

# COSORI®

## User Manual

### TurboBlaze™ 6.0-Quart Air Fryer



#### Questions or Concerns?

support@cosori.com | 1-888-402-1684

Mon–Fri, 9:00 am–5:00 pm PST/PDT

 Thank you for  
your purchase! 

(We hope you love your new air fryer as much as we do)



### Get Creative with COSORI

Download the free VeSync app to access original recipes and video tutorials from the COSORI chefs, interact with our online community, and more!



*explore*

our digital recipe gallery  
[cosori.com](https://www.cosori.com)



*enjoy*

weekly, featured recipes  
*made exclusively by our in-house chefs*

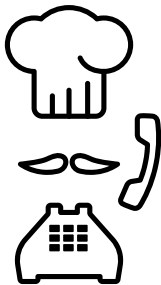

### CONTACT OUR CHEFS

Our helpful, in-house chefs are ready to assist you with any questions you might have!

**Email:** [recipes@cosori.com](mailto:recipes@cosori.com)

**Toll-Free:** 1-888-402-1684

Mon–Fri, 9:00 am–5:00 pm PST/PDT

On behalf of all of us at COSORI,

*Happy cooking!*

## Table of Contents

Package Contents	3
Specifications	3
Important Safeguards	4
Getting To Know Your Air Fryer	7
Before First Use	10
Using Your Air Fryer	12
Care & Maintenance	17
Accessories	17
Troubleshooting	18
Warranty Information	20
Customer Support	23

## Package Contents

1 x TurboBlaze™ 6.0-Quart Air Fryer
1 x Crisper Plate
1 x User Manual
1 x Recipe Book

## Specifications

<b>Model</b>	CAF-DC601-KUS
<b>Power Supply</b>	AC 120V, 60Hz
<b>Rated Power</b>	1,725W
<b>Capacity</b>	6 qt / 5.7 L (serves 3–5 people)
<b>Temperature Range</b>	90°–450°F / 30°–230°C
<b>Time Range</b>	1 min–24 hr
<b>Dimensions (including handle)</b>	11.8 x 14.4 x 11.9 in / 30.0 x 36.5 x 30.1 cm
<b>Dimensions (not including handle)</b>	11.8 x 11.8 x 11.9 in / 30.0 x 30.0 x 30.1 cm
<b>Weight</b>	13.2 lb / 6 kg

# READ AND SAVE THESE INSTRUCTIONS

## IMPORTANT SAFEGUARDS

---

Follow basic safety precautions when using your air fryer. Read all instructions.

### Key Safety Points

- **Do not** touch hot surfaces. Use handle.
- Use caution when turning the basket over after cooking, as the hot crisper plate may fall out and create a safety hazard.
- **Do not** block any ventilation openings. Hot steam is released through openings. Keep your hands and face clear of openings.
- **CAUTION:** The hot crisper plate may fall out when turning the basket over.

#### Note:

- *Firmly insert the crisper plate into the basket to reduce the chance of it falling out.*
- ***Always** use tongs to carefully remove hot food.*

### General Safety

- To protect against electric shock, **do not immerse the air fryer** housing, cord, or plug in water or other liquids.
- Closely supervise children near your air fryer.
- Unplug when not in use and before cleaning. Allow to cool before putting on or taking off parts.
- **Do not** use your air fryer if it is damaged, not working, or if the cord or plug is damaged. Contact **Customer Support** (see page 23).
- **Do not** use third-party replacement parts or accessories, as this may cause injuries.
- **Do not** use outdoors.
- **Do not** place the air fryer or any of its parts on a stove, near gas or electric burners, or in a heated oven.
- Be extremely cautious when moving your air fryer (or removing the basket) if it contains hot oil or other hot liquids.
- **Always** place the crisper plate on a heat-resistant surface after removing it from the basket.
- **Do not** clean with metal scouring pads. Metal fragments can break off the pad and touch electrical parts, creating a risk of electric shock.
- **Do not** place anything on top of your air fryer. **Do not** store anything inside your air fryer.
- This air fryer is not intended for use by persons (including children) with reduced physical, sensory, or mental capabilities, or lack of experience and knowledge, unless they have been given supervision or instruction concerning use of the air fryer by a person responsible for their safety.
- **Do not** allow children to clean or perform maintenance on the air fryer unless they are supervised.
- Children should be supervised to ensure that they **do not** play with the air fryer.
- This air fryer is not intended to be operated by means of an external timer or separate remote-control system.
- **Only** use your air fryer as directed in this manual.
- Not for commercial use. Household use **only**.

## While Air Frying

- An air fryer works with hot air **only**. **Never** fill the basket with oil or fat.
- **Never** use your air fryer without the basket in place.
- **Do not** place oversized foods or metal utensils into your air fryer.
- **Do not** overfill the air fryer basket. Heaping amounts of food may touch the heating coils and cause a fire hazard.
- **Do not** touch accessories (including the crisper plate) during or immediately after air frying.
- **Do not** place paper, cardboard, non-heat-resistant plastic, or similar materials into your air fryer.
- **Never** put baking or parchment paper into the air fryer without food on top. Air circulation can cause paper to lift and touch heating coils.
- **Always** use heat-safe containers. Be extremely cautious if using containers that aren't metal or glass.
- Keep your air fryer away from flammable materials (curtains, tablecloths, etc.). Use on a flat, stable, heat-resistant surface away from heat sources or liquids.
- Immediately turn off and unplug your air fryer if you see dark smoke coming out. White smoke is normal, caused by heating fat or food splashing, but dark smoke means that food is burning or there is a circuit problem. Wait for the smoke to clear before pulling the basket out. If the cause was not burnt food, contact **Customer Support** (page 23).
- To turn the air fryer off, press  once. The air fryer will beep, and all of the buttons will shut off except , which will turn orange.

- To unplug, grab the plug and pull from the outlet. **Never** pull from the power cord.
- **Do not** leave your air fryer unattended while in use.

## Power & Cord

- Turn off the air fryer before removing the plug from the outlet.
- **Do not** let the power cord (or any extension cord) hang over the edge of a table or counter, or touch hot surfaces.
- Remove and discard the plug's protective cover to prevent a choking hazard.
- **Never** use an outlet below the counter when plugging in your air fryer.
- Your air fryer has a polarized plug (one prong is wider than the other), which fits into a polarized outlet only one way. If the plug does not fit, reverse the plug. If it still does not fit, **do not** use the plug in that outlet. **Do not** alter the plug in any way.
- Your air fryer should only be used with **120V, 60Hz** electrical systems. **Do not** plug into another type of outlet.
- Keep the air fryer and its cord out of reach of children.
- A short power-supply cord is provided to reduce the risk resulting from becoming entangled in or tripping over a longer cord.

## Extension Cords

- Longer extension cords are available and may be used if care is exercised in their use. If a longer extension cord is used:
  - The marked electrical rating of the extension cord should be at least as great as the electrical rating of the air fryer.
  - The cord should be arranged so that it will not drape over the countertop or tabletop where it can be pulled on by children or tripped over unintentionally.
- If the power-supply cord is damaged, it must be replaced by Arovast or similarly qualified persons in order to avoid an electric or fire hazard. Please contact **Customer Support** (page 23).

## Electromagnetic Fields (EMF)

The COSORI Air Fryer complies with all standards regarding electromagnetic fields (EMF). If handled properly and according to the instructions in this user manual, the appliance is safe to use based on scientific evidence available today.

**Note:** *Items marked with the following symbol may reach high temperatures and should be handled carefully.*



**CAUTION:** Hot surface.

# SAVE THESE INSTRUCTIONS

# GETTING TO KNOW YOUR AIR FRYER

Your COSORI Air Fryer uses a DC motor which heats up the air fryer quicker, cooks faster, and allows for precise temperature and fan control, so your food cooks exactly the way you want it. With user-friendly one-touch controls, a nonstick basket, and an intuitive, safe design, the COSORI TurboBlaze™ Air Fryer is the star of your kitchen.

## Note:

- **Do not** try to open the top of the air fryer. This is not a lid.
- The basket and crisper plate are made of aluminum metal with nonstick coating.

## Air Fryer Diagram

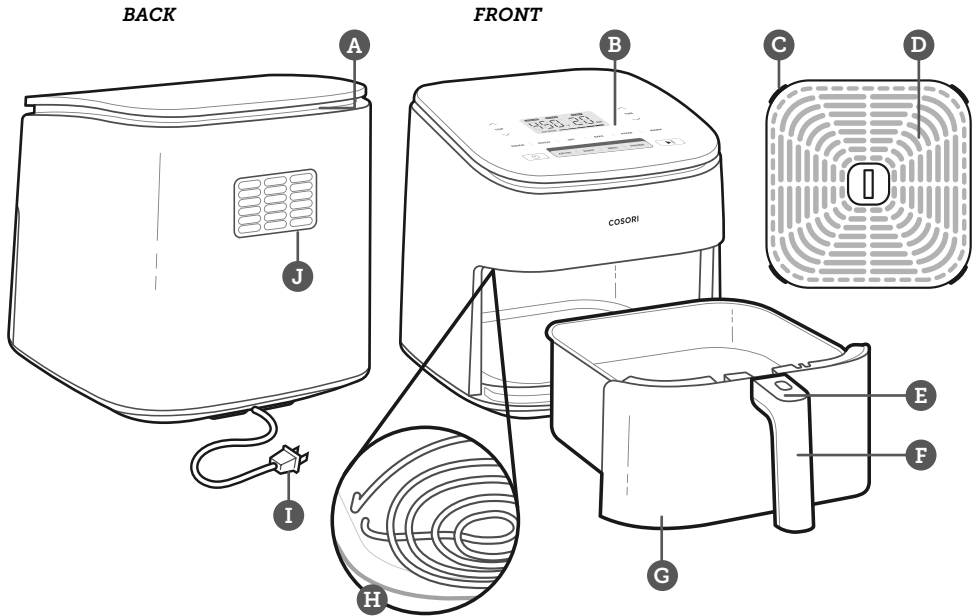

A. Air Inlet

B. Control Screen

C. Silicone Stoppers

D. Crisper Plate

E. Basket Release Button

F. Basket Handle

G. Basket

H. Heating Elements

I. Power Cord

J. Air Outlet

# Display Diagram

**Note:** When you tap a button to use a function, it will turn orange to show that it is selected.

## Control Panel

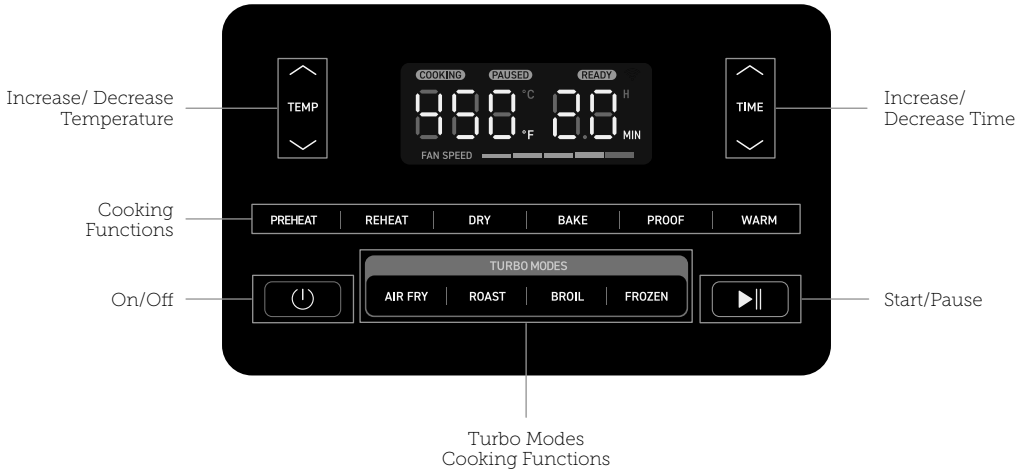

## Cooking Functions

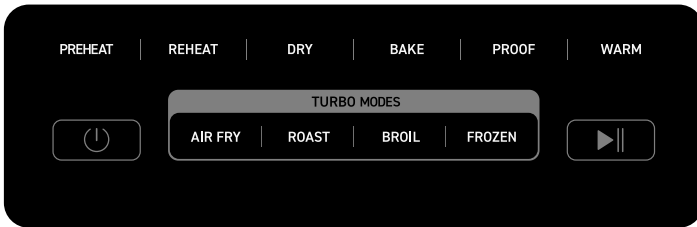



# Display

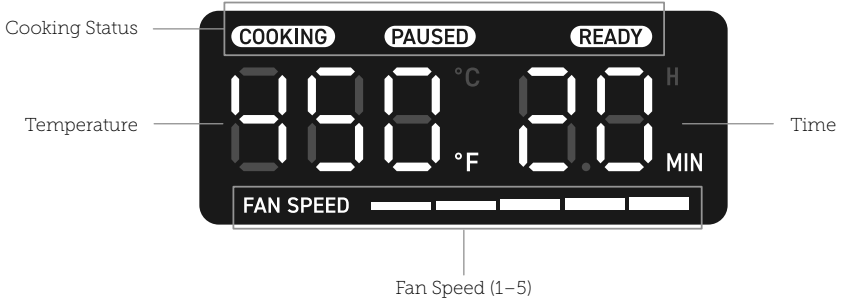

# Display Messages

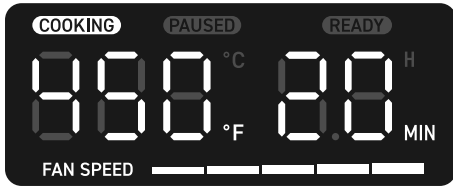

Cooking

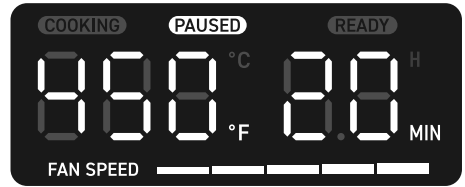

Paused

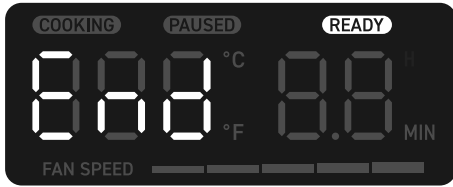

Ready

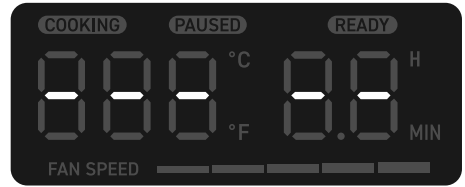

Remove the basket

# BEFORE FIRST USE

---

## Setting Up

1. Remove and discard all packaging from the air fryer, including any temporary stickers and the protective cover fitted over the power plug.
2. Place the air fryer on a stable, level, heat-resistant surface. Keep away from areas that can be damaged by steam (such as walls or cupboards).

**Note:** Leave 5 inches / 13 cm of space behind and above the air fryer. **[Figure 1.1]** Leave enough room in front of the air fryer to remove the basket.

3. Wash both the basket and crisper plate thoroughly, using either a dishwasher or a non-abrasive sponge.
4. Wipe the inside and outside of the air fryer with a slightly moist cloth. Dry with a towel.
5. Place the crisper plate back into the basket. Tilt the crisper plate to insert one side first, then press down on the other side.
6. Place the basket inside the air fryer.

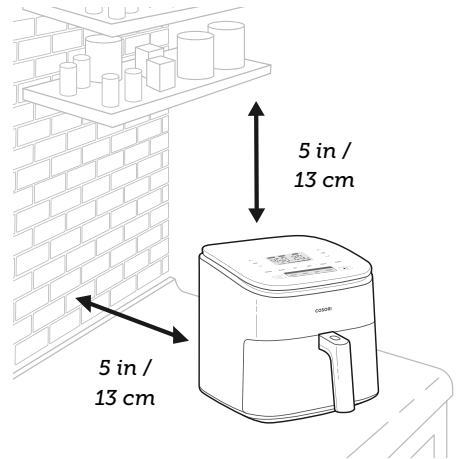

Figure 1.1

## Test Run

A test run will help you become familiar with your air fryer, make sure it's working correctly, and clean it of possible residues in the process.

1. Make sure the air fryer basket is empty and plug in the air fryer.
2. Tap **AIR FRY**. The display will show "385°F" and "10 MIN".
3. Tap ► to begin. When finished, the air fryer will beep and the display will show "End".
4. Press the basket release button and remove the basket. Let the basket cool completely for 10–30 minutes.

**Note:**

- Use caution when turning the basket over after cooking, as the hot crisper plate may fall out and create a safety hazard.
- **Do not** unscrew the basket handle from the basket.

## Silicone Stoppers

- The crisper plate contains 4 silicone stoppers made of food-safe material. These stoppers keep the plate fitted to the bottom of the basket.
- When placing the crisper plate into the basket, tilt the crisper plate to insert one side first, then press down on the other side. **[Figure 1.2]**

**Note:** Forcing the crisper plate into the basket incorrectly may cause damage.

- Make sure children **do not** play with the silicone stoppers or swallow them.

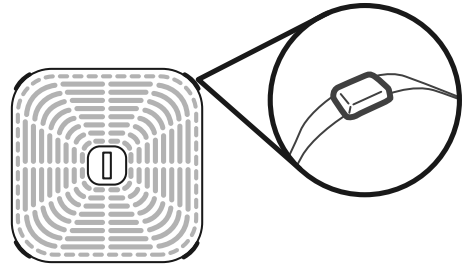

Figure 1.2

# USING YOUR AIR FRYER

## Note:

- **Do not** place anything on top of your air fryer. This will disrupt airflow and cause poor air frying results. [Figure 2.1]
- An air fryer is not a deep fryer. **Do not** fill the basket with oil, frying fat, or any liquid.
- When taking the basket out of the air fryer, be careful of hot steam.

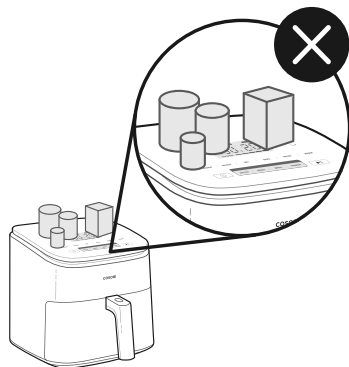

Figure 2.1

## Preheating

We recommend preheating before placing food inside the air fryer, unless your air fryer is already hot. Food will not cook thoroughly without preheating.

1. Tap  $\odot$  to turn on the display.
2. Tap **PREHEAT**. The display will show "400°F" and "4 MIN".
3. Optionally, tap  $\sphericalangle$  or  $\sphericalangle$  to change the temperature. The time will adjust automatically.
4. Tap  $\blacktriangleright$  to begin preheating.
5. When the time has finished, the air fryer will beep and the display will show "End".

## Note:

- If no buttons are pressed for 30 minutes, the air fryer will clear all settings and turn off.
- Preheat uses a fan speed of 4.
- When adjusting the temperature, the time will automatically adjust based on the chart below.

Temperature	Time (Minutes)
345°–450°F / 175°–230°C	4
240°–340°F / 115°–170°C	3
170°–235°F / 75°–110°C	2

## Cooking Functions

Using a cooking function is the easiest way to air fry. Functions are programmed with an ideal time, temperature, and fan speed for cooking certain foods, see **Cooking Chart** (page 14).

All cooking functions' time and temperature can be adjusted.

To customize a cooking function:

1. Select the function's button you want to customize.
2. Tap  $\sphericalangle$  or  $\sphericalleftarrow$  to change the function's time and temperature.
3. To save, press and hold the function's button for 3 seconds until you hear a beep.

**Note:**

- Press and hold  $\sphericalangle$  or  $\sphericalleftarrow$  to rapidly increase or decrease the time or temperature.
- Fan speed cannot be customized.

To reset all cooking functions:

- Press and hold  $\text{⏻}$  for 15 seconds.

## Turbo Modes

- Turbo Modes cooking functions (Air Fry, Roast, Broil, Frozen) quickly cook food using the highest fan speed (5).
- We recommend using the crisper plate for all Turbo Modes functions to take full advantage of the 360° air flow when cooking.

## Air Frying

1. Place the crisper plate into the basket. The crisper plate allows excess oil to drip down to the bottom of the basket.

**Note:** The crisper plate may not be used for certain recipes, such as muffins and breads.

2. Preheat your air fryer (see page 12).
3. When the air fryer beeps and the display shows "End", add food to the basket.
4. Select a cooking function.

**Note:** Cooking functions are programmed with an ideal time, temperature, and fan speed for cooking certain foods. The air fryer will default to the Air Fry function if no other function is selected.

5. Optionally, change the temperature and time by tapping  $\sphericalangle$  or  $\sphericalleftarrow$ . You can do this anytime during cooking.
6. Tap  $\text{▶||}$  to begin air frying.
7. The air fryer will beep when finished. The display will show



- Optionally, tap WARM. Tap  $\sphericalangle$  or  $\sphericalleftarrow$  to change the time (1–60 minutes).
8. Take the basket out of the air fryer, being careful of hot steam. Use tongs or heat-safe utensils to remove the food from the basket.
  9. Allow to cool before cleaning.

# Cooking Chart

**Note:** Results may vary. For recipes and cooking inspiration, check out the VeSync app and Recipe Book.

Function		Default Temperature	Default Time	Temperature Range	Time Range	Fan Speed
Turbo Modes	Air Fry	385°F / 195°C	10 min	300°–450°F / 150°–230°C	1–60 min	5
	Roast	425°F / 220°C	12 min	350°–450°F / 175°–230°C	1–60 min	5
	Broil	450°F / 230°C	5 min	425°–450°F / 220°–230°C	1–30 min	5
	Frozen	390°F / 200°C	14 min	300°–450°F / 150°–230°C	1–30 min	5
Reheat		390°F / 200°C	5 min	300°–425°F / 150°–220°C	1–60 min	4
Bake		330°F / 165°C	20 min	260°–400°F / 125°–205°C	1–60 min	3
Dehydrate ("DRY")		135°F / 55°C	6 hr	100°–200°F / 35°–95°C	1–24 hr	1
Proof		90°F / 30°C	1 hr	90°–110°F / 30°–45°C	1–12 hr	1
Preheat		400°F / 205°C	4 min (auto adjust)	170°–450°F / 75°–230°C	-	4
Keep Warm ("WARM")		170°F / 75°C	30 min	-	1–60 min	2

\*See **Cooking Tips** (page 15) for more information.

# Cooking Tips

## Overfilling

- If the basket is overfilled, food will cook unevenly.

## Using Oil

- Adding a small amount of oil to your food will make it crispier. Use no more than 2 US tbsp / 30 mL of oil.
- Oil sprays are excellent for applying small amounts of oil evenly to all food items.

## Food Tips

- You can air fry any frozen foods or goods that can be baked in an oven.
- The Frozen function is ideal for small or breaded items, such as nuggets, meatballs, and pot stickers.
- To make cakes, hand pies, or any food with filling or batter, place food in a heat-safe container before placing in the basket.
- Air frying high-fat foods will cause fat to collect underneath the crisper plate. To avoid excess smoke while cooking, pour out fat drippings after cooking.
- Liquid-marinated foods create splatter and excess smoke. Pat these foods dry before air frying.
- Refer to the **Cooking Chart** to select the ideal cooking function for your recipe (see page 14).



## French Fries

- Add ½–1 US tbsp / 8–15 mL oil for crispiness.
- When making fries from raw potatoes, soak uncooked fries in water for 15 minutes to remove starch prior to frying. Pat dry with a towel before adding oil.
- Cut uncooked fries smaller for crispier results. Try cutting fries into ¼- by 3-inch / 0.6- by 7.6-cm strips.



**Note:** For more tips and recipes, check out the *VeSync app* and *COSORI website*.

## More Functions

### Switching Temperature Units

- Press and hold **TEMP**  and  for 3 seconds.
- The temperature unit will change from Fahrenheit to Celsius.
- Repeat to switch back to Fahrenheit.

### Pausing

- Tap  to pause cooking. The air fryer will stop heating, and  will blink until you tap  again to resume cooking.
- After 30 minutes of inactivity, the air fryer will turn off.
- This function allows you to pause the cooking program without removing the basket from the air fryer.

### Automatically Resume Cooking

- If you pull out the basket, the air fryer will pause cooking automatically. The display will turn off temporarily as a safety feature.
- When you return the basket, the air fryer will automatically resume cooking based on your previous settings.

### Automatic Shutoff

- If the air fryer has no active functions, the air fryer will clear all settings and turn off after 30 minutes of inactivity.

### Overheat Protection

- If the air fryer overheats, it will automatically shut down as a safety feature.
- Let the air fryer cool down completely before using it again.



# CARE & MAINTENANCE

---

**Note:**

- **Always** clean the air fryer basket and crisper plate after every use.
  - Lining the basket with foil (except the crisper plate) may make cleanup easier.
1. Turn off and unplug the air fryer. Allow it to cool completely before cleaning. Pull out the basket for faster cooling.
  2. Wipe the outside of the air fryer with a moist cloth, if necessary.
  3. The basket and crisper plate are dishwasher-safe. You can also wash the basket and crisper plate with hot, soapy water and a non-abrasive sponge. Soak if necessary.

**Note:** The basket and crisper plate have a nonstick coating. Avoid using metal utensils and abrasive cleaning materials.

4. For stubborn grease:
  - a. In a small bowl, mix 2 US tbsp / 30 g of baking soda and 1 US tbsp / 15 mL of water to form a spreadable paste.
  - b. Use a sponge to spread the paste on the basket and crisper plate and scrub. Let the basket and crisper plate sit for 15 minutes before rinsing.
  - c. Wash basket with soap and water before using.

5. Clean the inside of the air fryer with a slightly moist, non-abrasive sponge or cloth. **Do not** immerse in water. If needed, clean the heating coil to remove food debris. [Figure 3.1]
6. Dry before using.

**Note:** Make sure the heating coil is completely dry before turning on the air fryer.



Figure 3.1

# ACCESSORIES

---

Additional and replacement accessories are available for your air fryer. For more information, contact **Customer Support** (see page 23).

# TROUBLESHOOTING

Problem	Possible Solution
<b>The air fryer will not turn on.</b>	Make sure the air fryer is plugged in.
	Push the basket securely into the air fryer.
<b>Food is not completely cooked.</b>	Place smaller batches of food items into the basket. If the basket is overstuffed, then food will be undercooked.
	Increase cooking temperature or time.
<b>Food is not crispy after air frying.</b>	Spraying or brushing a small amount of oil on food can increase crispiness (see <b>Cooking Tips</b> , page 15).
<b>French fries are not cooked correctly.</b>	See <b>French Fries</b> , page 15.
<b>Basket will not slide into the air fryer securely.</b>	Make sure the basket is not overfilled with food.
<b>White smoke or steam is coming out of the air fryer.</b>	The air fryer may produce some white smoke or steam when you use it for the first time or during cooking. This is normal.
	Make sure the basket and the inside of the air fryer are cleaned properly and not greasy.
	Cooking greasy foods will cause oil to collect beneath the crisper plate. This oil will produce white smoke, and the basket may be hotter than usual. This is normal and should not affect cooking. Handle the basket with care.
<b>Dark smoke is coming out of the air fryer.</b>	Immediately unplug your air fryer. Dark smoke means that food is burning or there is a circuit problem. Wait for smoke to clear before pulling the basket out. If the cause was not burnt food, contact <b>Customer Support</b> (see page 23).
<b>The air fryer has a plastic smell.</b>	Any air fryer may have a plastic smell from the manufacturing process. This is normal. Follow the instructions for a <b>Test Run</b> (page 11) to get rid of the plastic smell. If a plastic smell is still present, please contact <b>Customer Support</b> (see page 23).
<b>Display shows Error Code "E01/E21"</b>	There is an open circuit in the temperature monitor. Contact <b>Customer Support</b> (see page 23).
<b>Display shows Error Code "E02/E22"</b>	There is a short circuit in the temperature monitor. Contact <b>Customer Support</b> (see page 23).
<b>Display shows Error Code "E04"</b>	The air fryer has been plugged into a 220–240V outlet. Turn off and unplug the air fryer. <b>Only</b> use the air fryer with 120V, 60Hz outlets.

If your problem is not listed, please contact **Customer Support** (see page 23).

# FEDERAL COMMUNICATION COMMISSION INTERFERENCE STATEMENT - PART 15

---

This device complies with Part 15 of the FCC Rules. Operation is subject to the following two conditions:

1. This device may not cause harmful interference, and
2. This device must accept any interference received, including interference that may cause undesired operation.

NOTE: This equipment has been tested and found to comply with the limits for a Class B digital device, pursuant to Part 15 of the FCC Rules. These limits are designed to provide reasonable protection against harmful interference in a residential installation. This equipment generates, uses and can radiate radio frequency energy and, if not installed and used in accordance with the instructions, may cause harmful interference to radio communications. However, there is no guarantee that interference will not occur in a particular installation. If this equipment does cause harmful interference to radio or television reception, which can be determined by turning the equipment off and on, the user is encouraged to try to correct the interference by one or more of the following measures:

- Reorient or relocate the receiving antenna.
- Increase the separation between the equipment and receiver.
- Connect the equipment into an outlet on a circuit different from that to which the receiver is connected.
- Consult the dealer or an experienced radio/TV technician for help.

**FCC Caution:** Any changes or modifications not expressly approved by the party responsible for compliance could void the user's authority to operate this equipment.

## FCC SUPPLIER'S DECLARATION OF CONFORMITY (SDOC)

---

Arovast Corporation hereby declares that this equipment is in compliance with FCC requirements. The declaration of conformity may be consulted in the support section of our website, accessible from [www.cosori.com](http://www.cosori.com)

# WARRANTY INFORMATION

---

<b>Product Name</b>	TurboBlaze™ 6.0-Quart Air Fryer
<b>Model</b>	CAF-DC601-KUS
<i>For your own reference, we strongly recommend that you record your order ID and date of purchase.</i>	
<b>Date of Purchase</b>	
<b>Order ID</b>	

## TERMS & POLICY

Register your products at <https://warranty.cosori.com/warranty> to stay up to date with important product information such as product updates, limited warranties, usage and maintenance recommendations, and notifications concerning safety warnings or product recalls. Registration is not required to claim your limited warranty.

### Two (2) Year Limited Consumer Product Warranty

Arovast Corporation ("Arovast") warrants that the product shall be free from defects in material and workmanship for a period of **2 years from the date of original purchase** ("Limited Warranty Period"), provided the product was used in accordance with its use and care instructions (e.g. in the intended environment and under normal circumstances).

### Your Limited Warranty Benefits

During the Limited Warranty Period and subject to this limited Warranty Policy, Arovast will, in its sole and exclusive discretion, either (i) refund the purchase price if the purchase was made directly from the online COSORI store, (ii) repair any defects in material or workmanship, (iii) replace the product with another product of equal or greater value, or (iv) provide store credit in the amount of the purchase price.

### Who Is Covered?

This limited warranty extends only to the original consumer purchaser of the product and is not transferable to any subsequent owner of the product, regardless of whether the product transferred ownership during the specified term of the limited warranty. The original consumer purchaser must provide verification of the defect or malfunction and proof of the date of purchase to claim the Limited Warranty Benefits.

### Be Aware of Unauthorized Dealers or Sellers

This limited warranty does not extend to products purchased from unauthorized dealers or sellers. Arovast's limited warranty only extends to products purchased from authorized dealers or sellers that are subject to Arovast's quality controls and have agreed to follow its quality controls. Please be aware, products purchased from an unauthorized website or dealer may be counterfeit, used, defective, or may not be designed for use in your country. You can protect yourself and your products by making sure you only purchase from Arovast or its authorized dealers.

If you have any questions about a specific seller, or if you think you may have purchased your product from an unauthorized seller, please contact our Customer Support via [support@cosori.com](mailto:support@cosori.com).

### What's Not Covered?

- Normal wear and tear, including parts that might wear out over time (e.g. batteries, filters, cleaning brush, essential oil pads, etc.).
- If the proof-of-purchase has been altered in any way or is made illegible.

- If the model number, serial number or production date code on the product has been altered, removed or made illegible.
- If the product has been modified from its original condition.
- If the product has not been used in accordance with directions and instructions in the user manual.
- Damages caused by connecting peripherals, additional equipment or accessories other than those recommended in the user manual.
- Damages or defects caused by accident, abuse, misuse, or improper or inadequate maintenance.
- Damages or defects caused by service or repair of the product performed by an unauthorized service provider or by anyone other than Arovast.
- Damages or defects occurring during commercial use, rental use, or any use for which the product is not intended.
- If the unit has been damaged, including but not limited to damage by animals, lightning, abnormal voltage, fire, natural disaster, transportation, dishwasher, or water (unless the user manual expressly states that the product is dishwasher-safe).
- Incidental and consequential damages.
- Damages or defects exceeding the cost of the product.

### **Claiming Your Limited Warranty Service in 5 Simple Steps:**

1. Make sure your product is within the specified limited warranty period.
2. Make sure you have a copy of the invoice and order ID or proof-of-purchase.
3. Make sure you have your product.  
**DO NOT** dispose of your product before contacting us.
4. Contact our Customer Support team via [support@cosori.com](mailto:support@cosori.com).
5. Once our Customer Support team has approved your request, please return the product with a copy of the invoice and order ID.

### **Sole and Exclusive Remedy**

THE FOREGOING LIMITED WARRANTY CONSTITUTES AROVAST CORPORATION'S EXCLUSIVE LIABILITY, AND YOUR SOLE AND EXCLUSIVE REMEDY, FOR ANY BREACH OF ANY WARRANTY OR OTHER NONCONFORMITY OF THE PRODUCT COVERED BY THIS LIMITED PRODUCT WARRANTY STATEMENT. THIS LIMITED WARRANTY IS EXCLUSIVE, AND IN LIEU OF ALL OTHER WARRANTIES. NO EMPLOYEE OF AROVAST CORPORATION OR ANY OTHER PARTY IS AUTHORIZED TO MAKE ANY WARRANTY IN ADDITION TO THE LIMITED WARRANTY IN THIS LIMITED PRODUCT WARRANTY STATEMENT.

### **Disclaimer of Limited Warranties**

TO THE FULLEST EXTENT PROVIDED BY APPLICABLE LAW, EXCEPT AS WARRANTED IN THIS LIMITED PRODUCT WARRANTY POLICY, AROVAST CORPORATION PROVIDES THE PRODUCTS YOU PURCHASE FROM AROVAST CORPORATION "AS IS" AND AROVAST CORPORATION HEREBY DISCLAIMS ALL WARRANTIES OF ANY KIND, WHETHER EXPRESS OR IMPLIED, STATUTORY, OR OTHERWISE, INCLUDING BUT NOT LIMITED TO ANY WARRANTIES OF MERCHANTABILITY, NON-INFRINGEMENT, AND FITNESS FOR PARTICULAR PURPOSE.

## **Limitations of Liability**

TO THE FULLEST EXTENT PROVIDED BY APPLICABLE LAW, IN NO EVENT WILL AROVAST CORPORATION, ITS AFFILIATES, OR THEIR LICENSORS, SERVICE PROVIDERS, EMPLOYEES, AGENTS, OFFICERS, OR DIRECTORS BE LIABLE FOR:

(a) DAMAGES OF ANY KIND ARISING OUT OF OR IN CONNECTION WITH PRODUCTS PURCHASED FROM AROVAST CORPORATION IN EXCESS OF THE PURCHASE PRICE PAID BY THE PURCHASER FOR SUCH PRODUCTS, OR

(b) INDIRECT, SPECIAL, INCIDENTAL, CONSEQUENTIAL, OR PUNITIVE DAMAGES EVEN IF AROVAST CORPORATION OR ONE OF ITS SUPPLIERS HAS BEEN ADVISED OF THE POSSIBILITY OR LIKELIHOOD OF SUCH DAMAGES.

AND REGARDLESS OF WHETHER CAUSED BY TORT (INCLUDING NEGLIGENCE), BREACH OF CONTRACT, OR OTHERWISE. OUR LIABILITY SHALL UNDER NO CIRCUMSTANCES EXCEED THE ACTUAL AMOUNT PAID BY YOU FOR THE DEFECTIVE PRODUCT, NOR SHALL WE UNDER ANY CIRCUMSTANCES BE LIABLE FOR ANY CONSEQUENTIAL, INCIDENTAL, SPECIAL OR PUNITIVE DAMAGES OR LOSSES, WHETHER DIRECT OR INDIRECT.

EXCEPT AS COVERED BY THIS LIMITED PRODUCT WARRANTY STATEMENT, AROVAST CORPORATION SHALL NOT BE LIABLE FOR COSTS ASSOCIATED WITH THE REPLACEMENT OR REPAIR OF PRODUCTS PURCHASED FROM IT, INCLUDING, BUT NOT LIMITED TO, LABOR, INSTALLATION, OR OTHER COSTS INCURRED BY THE USER AND, IN PARTICULAR, ANY COSTS RELATING TO THE REMOVAL OR REPLACEMENT OF ANY PRODUCT.

## **OTHER RIGHTS YOU MAY HAVE**

SOME JURISDICTIONS DO NOT ALLOW FOR: (1) EXCLUSION OF IMPLIED WARRANTIES; (2) LIMITATION ON THE DURATION OF IMPLIED WARRANTIES; AND/OR (3) EXCLUSION OR LIMITATION OF INCIDENTAL OR CONSEQUENTIAL DAMAGES; SO THE DISCLAIMERS IN THIS POLICY MAY NOT APPLY TO YOU. IN THESE JURISDICTIONS YOU HAVE ONLY THE IMPLIED WARRANTIES THAT ARE EXPRESSLY REQUIRED TO BE PROVIDED IN ACCORDANCE WITH APPLICABLE LAW. THE LIMITATIONS OF WARRANTIES, LIABILITY, AND REMEDIES APPLY TO THE MAXIMUM EXTENT PERMITTED BY LAW.

ALTHOUGH THIS LIMITED WARRANTY GIVES YOU SPECIFIC LEGAL RIGHTS, YOU MAY HAVE OTHER RIGHTS IN YOUR JURISDICTION. THIS STATEMENT OF LIMITED WARRANTY IS SUBJECT TO APPLICABLE LAWS THAT APPLY TO YOU AND THE PRODUCT. PLEASE REVIEW THE LAWS IN YOUR JURISDICTION TO UNDERSTAND YOUR RIGHTS FULLY.

## **CHANGES TO THIS POLICY**

We may change the terms and availability of this limited warranty at our discretion, but any changes will not be retroactive.

This warranty is made by:

### **AROVAST CORPORATION**

1202 N. Miller St., Suite A  
Anaheim, CA 92806, USA

# CUSTOMER SUPPORT

---

If you have any questions or concerns about your new product, please contact our helpful Customer Support Team.

**Arovast Corporation**

1202 N. Miller St., Suite A  
Anaheim, CA 92806, USA

**Email:** [support@cosori.com](mailto:support@cosori.com)

**Toll-Free:** 1-888-402-1684

**Support Hours**

Mon–Fri, 9:00 am–5:00 pm PST/PDT

*\*Please have your invoice and order ID ready before contacting Customer Support.*

# COSORI®

**Questions or Concerns?**

Mon-Fri, 9:00 am-5:00 pm PST/PDT  
support@cosori.com | 1-888-402-1684