

COSORI®

User Manual

6.0-Quart Pressure Cooker



Questions or Concerns?

support@cosori.com | 1-888-402-1684

Mon-Fri, 9:00 am-5:00 pm PST/PDT



Thank you for
your purchase!



(We hope you love your new pressure cooker as much as we do)



join

the COSORI Cooks Community on Facebook
[facebook.com/groups/cosoricooks](https://www.facebook.com/groups/cosoricooks)



explore

our recipe gallery
www.cosori.com/recipes



enjoy

weekly, featured recipes
made exclusively by our in-house chefs



CONTACT OUR CHEFS

Our helpful, in-house chefs are ready to assist you with any questions you might have!

Email: recipes@cosori.com

Toll-Free: 1-888-402-1684

Mon–Fri, 9:00 am–5:00 pm PST/PDT

On behalf of all of us at COSORI,

Happy cooking!

Table of Contents

Package Contents	3
Specifications	3
Important Safeguards	4
Getting To Know Your Pressure Cooker	8
Pressure Cooker Diagram	8
Control Panel	9
Control Panel Buttons	10
Display	11
Pressure Cooker Lid	12
Sealing Ring	13
Anti-Block Shield	13
Float Valve	13
Inner Pot	13
Steam Rack	13
Pressure Cooking Stages	14
Releasing Pressure	14
Before First Use	16
Setting Up	16
Test Run	17
Cooking Functions	18
Cooking Functions Reference Chart (Pressure Cooking)	18
Cooking Functions Reference Chart (Non-Pressure Cooking)	19
Customize Cooking Function Settings	19
Pressure Cook	20
Slow Cook	21
Sauté	21
Ferment	22
Sous Vide	23
Delay Start	24
Keep Warm	24
Sterilize	25
Reset Customized Cooking Functions	26
Care & Maintenance	27
Cleaning the Pressure Cooker Base	27
Cleaning the Inner Pot, Lid, Lid Parts and Steam Rack	27
Cleaning the Condensation Collector	28
Cleaning the Sealing Ring	29
Eliminating Lingered Odor	29
Storage	29
Troubleshooting	30
Warranty Information	33
Customer Support	34

Package Contents

- 1 x 6.0-Quart Pressure Cooker
- 1 x Inner Pot
- 1 x Steam Rack
- 1 x Recipe Book
- 1 x User Manual
- 1 x Quick Reference Guide

Specifications

Model	CMC-CO601-SUS
Power Supply	AC 120V, 60Hz
Rated Power	1100W
Capacity	6.0 qt / 5.7 L (serves 4–6 people)
Dimensions	12.6D x 13.4W x 12.5H in / 32.0D x 34.0W x 31.7H cm
Weight	11.9 lb / 5.4 kg
Smart Control	No

Download the free VeSync app to access original recipes and video tutorials from the COSORI chefs, interact with our online community, and more!



READ AND SAVE THESE INSTRUCTIONS

IMPORTANT SAFEGUARDS

Follow basic safety precautions when using your pressure cooker. Read all instructions.

Key Safety Points

- This appliance cooks under pressure. Improper use may result in burn injuries. Make sure unit is properly closed before operating. See **Pressure Cooker Lid** (page 12).
- **CAUTION:** Always properly lock and seal the lid before pressure cooking.
- **Do not** touch hot surfaces. Use handles. **Never** move the cooker while it is in use.
- Use caution when opening the pressure cooker, as hot steam may come out, creating a safety hazard.
- **Do not** block any ventilation openings. Hot steam is released through openings. Keep your hands and face clear of openings.
- **Do not** touch the steam release valve or the area near the valve while cooking. **Do not** cover the area with a cloth.
- **Always** use heat-resistant gloves, pads, or oven mitts when handling hot materials.
- To reduce the risk of electrical shock **never** use the pressure cooker without the inner pot in place.
- **Do not** force the lid open. **Only** open the lid after all pressure has been released and the float valve has dropped back down into the lid.
- Unplug when not in use and before cleaning. Allow to cool before putting on or taking off parts, and before cleaning or storage.
- Close supervision is necessary when the pressure cooker is used by or near children.
- Children should be supervised to ensure that they **do not** play with the pressure cooker.
- **Do not** allow children to clean or perform maintenance on the pressure cooker.
- **Do not** use your pressure cooker if it is damaged, not working, or if the cord or plug is damaged. Contact **Customer Support** (see page 34).
- Using accessories or replacement parts not recommended by COSORI may cause injuries. Using any other pressure cooker lids or inner pots may cause injury and damage to the pressure cooker.
- **Do not** use outdoors.
- **Do not** place the pressure cooker or any of its parts on a stove, near gas or electric burners, or in a heated oven.
- **Do not** put food, liquid, or foreign objects on the heating plate.
- **Always** make sure the heating element is clean before inserting the inner pot.
- To disconnect, press **CANCEL**, then remove plug from wall outlet.

General Safety

- To protect against electric shock, **do not immerse the pressure cooker**, cord, or plug in water or liquid.
- Ensure the heating plate is clean and the underside of the inner pot is dry before inserting the inner pot.
- Be extremely cautious when moving your pressure cooker (or removing



WARNING

Read this manual carefully and completely and retain for future reference. Failure to adhere to safety instructions may result in serious injury or damage.

General Safety Cont.

the inner pot) if it contains hot oil or other hot liquids.

- **Always** place the inner pot on a heat-resistant surface after removing it from the pressure cooker.
- **Do not** use the included steam rack and inner pot in a microwave, on a stove or grill, or in an oven.
- **Do not** clean with metal scouring pads. Metal fragments can break off the pad and touch electrical parts, creating a risk of electric shock.
- **Do not** place anything on top of your pressure cooker.
- **Do not** store anything inside your pressure cooker or removable inner pot other than recommended COSORI accessories.
- The pressure cooker is not intended to be operated by means of an external timer or separate remote-control system.
- This pressure cooker is not intended for use by persons (including children) with reduced physical, sensory, or mental capabilities, or lack of experience and knowledge, unless they have been given supervision or instruction concerning use of the pressure cooker by a person responsible for their safety.
- **Do not** tamper with any of the safety mechanisms beyond instructed in **Care & Maintenance** (page 27).
- **Only** use as directed in this manual. **Do not** use for any purpose other than its intended use.
- Not for commercial use. Household use **only**.
- **Always** check the pressure release devices for clogging before use.

Note: See **Care & Maintenance** for instructions on how to clean the pressure cooker, all parts, and any accessories (page 27).

While Cooking

- **CAUTION:** Risk of electric shock. Cook **only** in the removable inner pot. **Do not** put any liquid directly into the pressure cooker.
- Use on a flat, stable, heat-resistant surface away from heat sources or liquids.
- The removable inner pot is extremely hot during use and can be heavy when full of ingredients.
- Extreme caution should be exercised when using containers constructed of materials other than metal or glass.
- Before use, make sure all vent openings are clear of food debris.
- **Always** move the pressure release switch to '**Seal**' when using pressurized cooking programs.
- Hot steam from the steam release valve can cause burns.
- **Always** make sure the sealing ring is properly secured in the sealing ring rack.
- **Always** make sure the pressure cooker is properly closed before pressure cooking.
- **Never** use your pressure cooker without adding liquid, as this will seriously damage the cooker.
- **Do not** exceed the maximum fill line (see **Inner Pot**, page 13).
- **CAUTION:** Avoid recipes that call for more than $\frac{1}{4}$ cup / 60 mL of oil or fat content. Using hot oil during pressure cooking may cause burns.
- **Do not** fill the inner pot higher than the "PC MAX—2/3" line (Pressure Cooking Maximum), as marked on the inner pot. When cooking foods that expand, such as rice or dehydrated vegetables, **do not** fill the cooker to more than $\frac{1}{2}$ of the inner pot's capacity.



WARNING

Read this manual carefully and completely and retain for future reference. Failure to adhere to safety instructions may result in serious injury or damage.

While Cooking Cont.

- Use extreme caution when cooking and venting food such as applesauce, cranberries, pearl barley, oatmeal, split peas, noodles, etc., as these foods may foam, froth, or splatter, and may clog the steam release pipe and/or steam release valve. **Do not** fill the inner pot higher than the “ $-1/2$ ” line when cooking these foods.
- Use caution when cooking doughy food to avoid food being ejected.
- Cooking meat with skin may swell under pressure. **Do not** prick the meat while the skin is swollen, as you may be burned.
- **Always** place hot accessories and the removable inner pot on a heat-resistant surface.
- The container must not be opened until the pressure has decreased sufficiently. **Do not** open the pressure cooker until the unit has cooled and all internal pressure has been released. If the handles are difficult to push apart, this indicates that the cooker is still pressurized - do not force it open. Any pressure in the cooker can be hazardous. **Never** force the lid open while there is pressure inside. **Always** wait for the float valve to drop before opening the lid. See **Pressure Cooker Lid** (page 12), **Float Valve** (page 13), and **Releasing Pressure** (page 14).
- **Only** use the original pressure cooking lid. Using any other lid to pressure cook may cause injury.
- Float valve up: **Do not** open lid. Float valve down: Safe to open lid. **Do not** force the lid open when the float valve is still in the up position.
- If the inner pot sticks to the lid, move the steam release switch to the ‘Vent’ position to release suction. See **Pressure Cooker Lid** (page 12).
- **Do not** put hands, face, or exposed skin over the steam release valve.
- **Do not** touch accessories or the inner pot during or immediately after cooking.
- **Do not** place paper, cardboard, or plastic into your pressure cooker, or any materials which may catch fire or melt.
- **Do not** use this pressure cooker for deep frying or pressure frying.
- **Do not** block any ventilation openings. Hot steam is released through openings. Keep your hand, face or exposed skin clear of the steam release valve or other openings while using the pressure cooker
- **WARNING:** Spilled food can cause serious burns. Keep the pressure cooker and cord away from children. **Never** drape cord over edge of counter, **never** use outlet below counter, and **never** use with an extension cord.
- The steam release valve and steam release pipe allow steam to escape. Check these parts regularly to make sure they are not blocked or clogged with food.
- **Do not** leave the pressure cooker unattended while in use.
- **Do not** touch the heating element after cooking, as it will be hot and may cause burns.
- To turn the pressure cooker off, press **CANCEL** to stop cooking, then unplug. To unplug, grab the plug and pull from the outlet. **Never** pull from the power cord.
- The ducts in the pressure regulator allowing the escape of steam should be checked regularly to ensure that they are not blocked.
- Always check the pressure release devices for clogging before use.
- The container must not be opened until the pressure has decreased sufficiently. see “page 11 Pressure Cooker Lid ,page 12 Float Valve, and page 13 Releasing Pressure.”
- **Do not** open the pressure cooker until the unit has cooled and all internal pressure has been released. If the handles are difficult



WARNING

Read this manual carefully and completely and retain for future reference. Failure to adhere to safety instructions may result in serious injury or damage.

to push apart, this indicates that the cooker is still pressurized - do not force it open. Any pressure in the cooker can be hazardous. See "page 11 Pressure Cooker Lid, page 12 Float Valve, and page 13 Releasing Pressure."

- Never put hands or face near the steam release valve.
- Float valve up: Do not open lid.
- Float valve down: Safe to open lid.
- For pressure cooking, the steam release switch must be in the 'Seal' position.
- If the inner pot sticks to the lid, move the steam release switch to the 'Vent' position to release suction.
- Only use the original pressure cooking lid. Using any other lid to pressure cook may cause injury.

Power & Cord

- This pressure cooker uses a short power-supply cord to reduce the risk of being pulled on or grabbed by children, or entangling or tripping.
- A short power-supply cord is provided to reduce the risk resulting from becoming entangled in or tripping over a longer cord.
- **Never** use with an extension cord. This pressure cooker is intended for countertop use only.
- **Do not** use a power adapter.

- Your pressure cooker has a 3-prong grounding plug, and should **only** be used with 120V, 60Hz electrical systems in North America. **Always** plug in to a grounded electrical outlet. **Do not** modify the plug in any way.
- **Do not** let the power cord hang over the edge of a table or counter, or touch hot surfaces.
- Keep the pressure cooker and its cord out of reach of children.
- **Never** use an outlet below the counter when plugging in your pressure cooker.
- If the power supply cord is damaged, it must be replaced by Arovast Corporation or similarly qualified persons in order to avoid an electric or fire hazard. Please contact **Customer Support** (page 34).

Electromagnetic Fields (EMF)

The COSORI pressure cooker complies with all standards regarding electromagnetic fields (EMF). If handled properly and according to the instructions in this user manual, the appliance is safe to use based on scientific evidence available today.

SAVE THESE INSTRUCTIONS



WARNING

Read this manual carefully and completely and retain for future reference. Failure to adhere to safety instructions may result in serious injury or damage.

GETTING TO KNOW YOUR PRESSURE COOKER

Your COSORI Pressure Cooker combines 9-in-1 cooking functions to cook foods 70% faster than traditional cooking methods. With user-friendly controls, cool-to-touch lid, nonstick inner pot, and safe steam release switch, the COSORI Pressure Cooker is the star of your kitchen.

Pressure Cooker Diagram

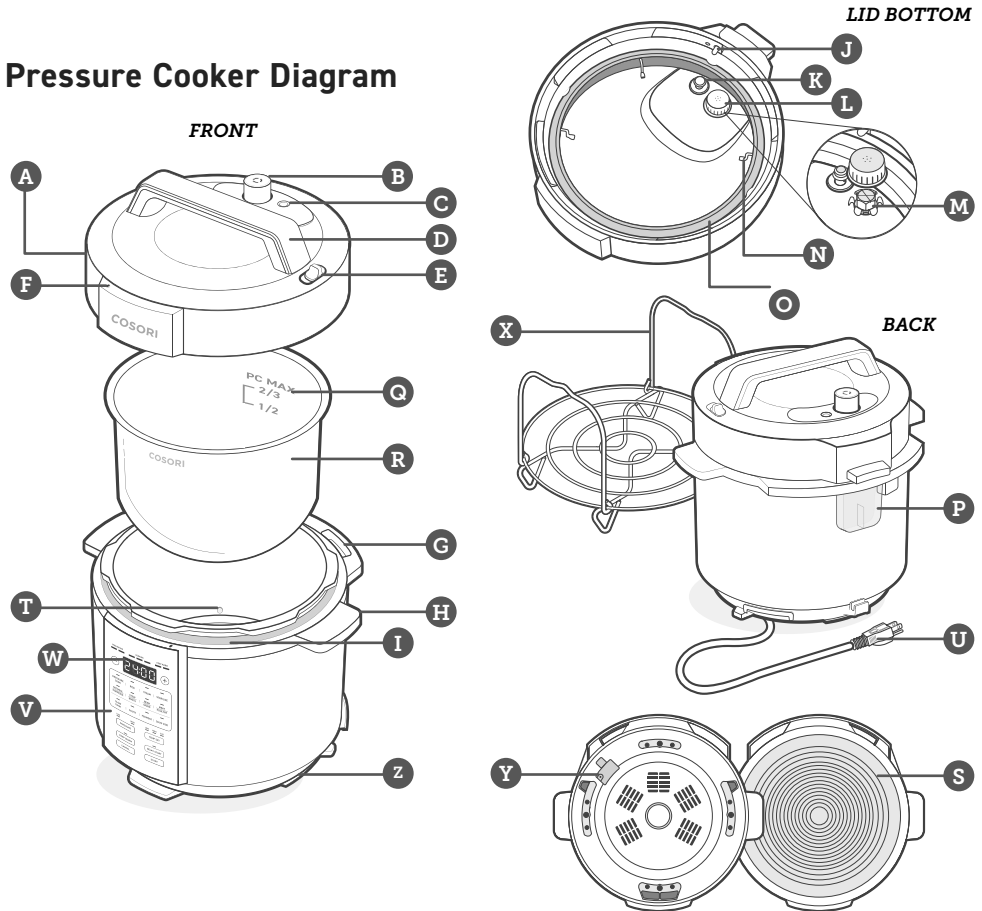

- | | | |
|------------------------------------|----------------------------------|----------------------------------|
| A. Pressure Cooker Lid | J. Locking Pin | S. Heating Element |
| B. Steam Release Valve | K. Silicone Cap | T. Non-Slip Silicone Pads |
| C. Float Valve | L. Anti-Block Shield | U. Power Cord |
| D. Lid Handle | M. Steam Release Pipe | V. Control Panel |
| E. Steam Release Switch | N. Sealing Ring Rack | W. Display |
| F. Lid Marker | O. Sealing Ring | X. Steam Rack |
| G. Lid Holder | P. Condensation Collector | Y. Cord Housing |
| H. Pressure Cooker Handles | Q. Fill Lines | Z. Pressure Cooker Base |
| I. Water Collection Channel | R. Inner Pot | |

Display Diagram

Control Panel

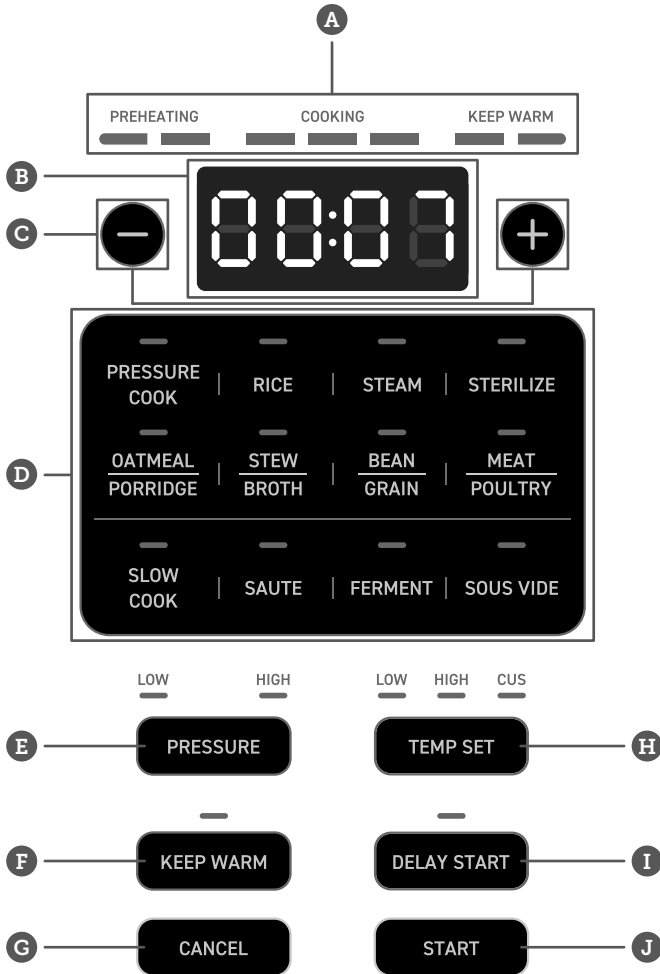

- A. Progress Bar
- B. Display
- C. Time & Temp Adjustment/
Buzzer On/Off
- D. Cooking Functions
- E. Pressure Set

- F. Keep Warm
- G. Cancel
- H. Temperature Set
- I. Delay Start
- J. Start

Control Panel Buttons

Progress Bar	Lights up depending on what cooking stage is active. Flashing lights indicate the work process at different stages.	
Display	<ul style="list-style-type: none"> • Displays cook time and temperature when a cooking function is selected/customized. • Time is shown in HH:MM format and counts up or down depending on the cooking function and cooking stage. • Displays temperature in °F (Fahrenheit) during non-pressure cooking except Keep Warm. • Displays messages about the lid and cooking status. See Display Messages (page 11). 	
Time & Temp Adjustment	Adjusts cook time, temperature, Delay Start timer, and Keep Warm timer.	
Buzzer On/Off	<ul style="list-style-type: none"> • Turns the pressure cooker sounds on/off. • When in standby: <ul style="list-style-type: none"> • Press and hold the + button until the display shows 'S ON', and the sound will turn on. • Press and hold the - button until the display shows 'S OFF', and the sound will turn off. <p>Note: Safety and error alerts cannot be turned off.</p>	
Cooking Functions	<p>Pressure Cooking Functions:</p> <ul style="list-style-type: none"> Pressure Cook Rice Steam Sterilize Oatmeal/Porridge Stew/Broth Bean/Grain Meat/Poultry 	<p>Non-Pressure Cooking Functions:</p> <ul style="list-style-type: none"> Slow Cook Sauté Ferment Sous Vide Keep Warm
Pressure Set	Sets 'Low' or 'High' pressure for pressure cooking.	
Temperature Set	<ul style="list-style-type: none"> • Sets 'Low', 'High', or 'Cus' (Custom) temperature. <p>Note: 'Cus' temperature setting allows you to increase or decrease the temperature for 'Sauté', 'Ferment', and 'Sous Vide' using the - or + buttons.</p>	
Keep Warm	<ul style="list-style-type: none"> • Turns Keep Warm on/off. • Can be used as a cooking function to reheat food. • For more information, see Keep Warm (page 24). <p>Note: Automatically on for all cooking functions except 'Sauté', 'Ferment', and 'Sous Vide'.</p>	
Delay Start	<ul style="list-style-type: none"> • Delays when a cooking function starts. <p>Note: Delay Start is not available for 'Sauté', 'Ferment', and 'Sous Vide'.</p>	
Start	Starts the cooking function selected.	
Cancel	Stops the cooking function at any time.	

Display

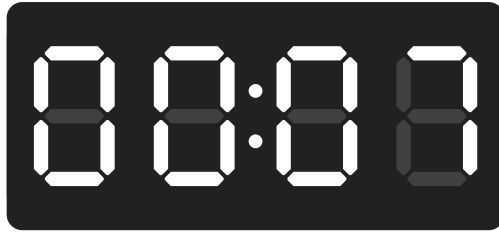

Display Messages

	The pressure cooker is on standby.
	The lid is off or not closed properly.
	The pressure cooker is pre-heating/pressurizing.
	The pressure cooker is ready for food to be added to the inner pot when using 'Sauté' cooking function.
	The display shows one of the following: <ol style="list-style-type: none">1. When a cooking function is active, the timer counts down and shows the remaining cook time until cooking is finished.2. When Delay Start is active, the timer counts down until the cooking function begins.3. When Keep Warm is active, the timer counts up from 00:00, showing the length of time that food has been warming.
	The cooking function has finished and 'Keep Warm' is off.
 	The pressure cooker may be overheating due to not enough liquid. For more information, see Troubleshooting (page 30).

Pressure Cooker Lid

- When cooking with a pressurized cooking function, the steam release switch will automatically move to 'Seal' when closed. **[Figure 1.1]**

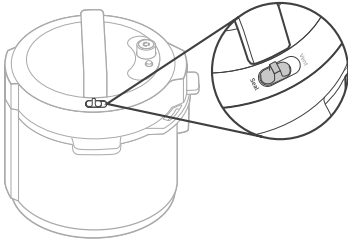

Figure 1.1

- When cooking with a non-pressurized cooking function, always move the steam release switch to 'Vent'. **[Figure 1.2]**

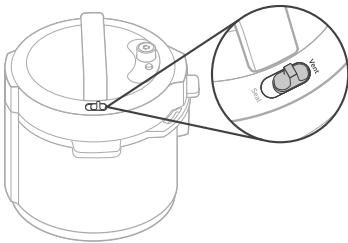

Figure 1.2

- The lid will lock when pressure is created and unlock when pressure is completely released.
- When using a non-pressurized cooking function, the lid **does not** lock so you can taste test food during cooking.
- To remove the lid, twist the lid counterclockwise to align the orange dot on the lid with the orange dot on the pressure cooker base and lift. **[Figure 1.3]**



Figure 1.3

- To close and secure the lid, align the orange dot on the lid with the orange dot on the pressure cooker base and twist clockwise. **[Figure 1.4]**



Figure 1.4

- The lid can be placed in the lid holder located in the back of the pressure cooker base for convenience. **[Figure 1.5]**

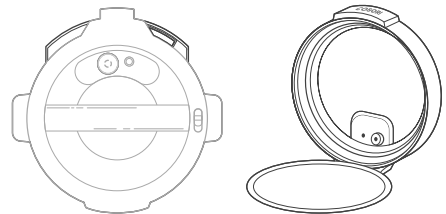

Figure 1.5

Note:

- Always** wait for the float valve to drop before removing the lid.
- The pressure cooker will make a sound when the lid is closed and opened so you know when the lid is secured and not secured.

Sealing Ring

The sealing ring (pre-installed) allows for an airtight seal between the inner pot and the lid.

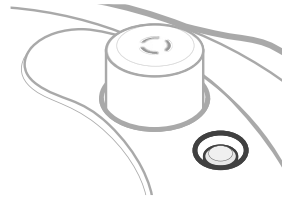

Figure 1.8

Note: Never try to remove the lid while the float valve is up.

Anti-Block Shield

The anti-block shield prevents food from clogging the steam release pipe and helps regulate pressure during the cooking process. [Figure 1.6]

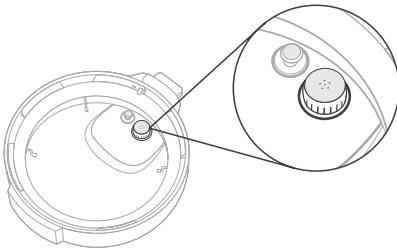

Figure 1.6

Float Valve

- The float valve indicates if there is pressure inside the cooker.
- Float valve up means there is pressure inside. [Figure 1.7]

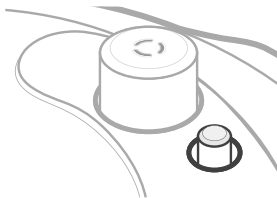

Figure 1.7

- The float valve indicates if there is pressure inside the cooker. Float valve down means there is no pressure inside. [Figure 1.8]

Inner Pot

The inner pot is made of aluminum metal with nonstick ceramic coating.

CAUTION:

- **Do not** fill the inner pot higher than the "PC MAX— $\frac{2}{3}$ " line (Pressure Cooking Maximum), as marked on the inner pot.
- **Do not** fill the inner pot higher than the " $-\frac{1}{2}$ " line when cooking food such as applesauce, cranberries, pearl barley, oatmeal, split peas, noodles, etc. These foods may foam, froth, or splatter, and may clog the steam release pipe and/or steam release valve.

Steam Rack

The steam rack helps food from touching liquid at the bottom of the inner pot. **Only** use heat-proof and water-proof containers on the steam rack and inside the pressure cooker.

Pressure Cooking Stages

There are 3 stages during pressure cooking:

1. PREHEATING:

- The display will show  and the progress bar will be lit up under 'PREHEATING'.
- The float valve will pop up once enough pressure has been created.

Note: *The time it takes for the pressure cooker to create pressure depends on what you are cooking, the amount of liquid, amount of food, and temperature setting. Frozen foods will take the longest time, while thawed food will be quicker. The preset cooking time does not include the preheating time, and the preheating time is not shown on the display.*

2. COOKING:

- Once pre-heating has finished, the display will begin the countdown timer. The progress bar will be lit up under 'COOKING'.
- The amount of pressure selected (LOW or HIGH) is maintained during the 'COOKING' phase.

Note: *Cook time, pressure level, and temperature can be adjusted at any time during cooking.*

3. KEEP WARM:

- Once cooking has finished, the display will show a timer starting from '00:00' and the progress bar will be lit up under 'KEEP WARM'.
- If you cancel the automatic Keep Warm before starting a pressurized cooking function, after cooking is finished, the display will show 'END' and begin to release pressure naturally until the float valve drops (see **Keep Warm**, page 24).
- If automatic Keep Warm is not canceled before cooking, after cooking is finished, the display will show the count up timer starting from '00:00' until you press CANCEL.

Note: *Optionally, you can use Quick Release or Timed Pressure Release to release the pressure (see **Releasing Pressure**, page 14).*

Releasing Pressure

When cooking with a pressurized cooking function (Pressure, Rice, Steam, Sterilize, Oatmeal/Porridge, Stew/Broth, Bean/Grain, and Meat/Poultry), you must depressurize the pressure cooker before opening the lid.

CAUTION: Always wait until the float valve drops before opening the lid.

There are 3 types of ways the pressure cooker can depressurize:

NATURAL RELEASE

The pressure cooker will release pressure normally over time.

- Cooking stops gradually and pressure is naturally released over time. When natural release completes, the float valve will drop.
- The steam release switch stays in the 'Seal' position. After the float valve has dropped, the lid will unlock automatically.
- We recommend naturally releasing pressure when cooking soups, stews, chilis, pastas, oatmeal, congee, beans, grains, and food that expand during cooking to avoid splatter.

Note: *Natural release can take up to 40 minutes depending on the dish.*

QUICK RELEASE

You can manually release steam by using the steam release switch (see page 8).

- Cooking stops quickly as pressure is released rapidly, along with **hot steam**.
- Once the cooking phase has finished, move the steam release switch to the 'Vent' position.

Note: *If the pressure cooker releases too much steam, move the steam release switch to 'Seal' and allow the rest of the pressure to naturally release.*

- We recommend quickly releasing pressure when cooking vegetables and seafood to make sure food is not overcooked.

TIMED NATURAL RELEASE

- Cooking gradually stops until the remaining pressure is quick released.
- Keep the steam release switch in the '**Seal**' position for a few minutes after cooking has finished, then move the switch to the '**Vent**' position to quick release the rest of the pressure.
- We recommend using timed natural release for food such as rice and grains.

Note: *Once the switch is moved to '**Vent**', the pressure won't be as strong as immediately quick releasing pressure.*

CAUTION:

- **Do not** place hands, face, or exposed skin over the steam release valve.
- **Do not** open the lid until pressure is finished releasing. The lid will stay locked until the float valve drops down.
- **Never** force the float valve down while it is still up.
- To avoid dangerous food splatter, **always** use natural release for foods that have a large liquid volume or high starch content (such as soup, porridge, or fruit jam).

BEFORE FIRST USE

Setting Up

1. Remove all plastic packaging from the pressure cooker. Read and remove all temporary stickers and warning cards.

Note: **Do not** remove the permanent warning sticker from the lid or the foil certification label from the pressure cooker base.

2. Place the pressure cooker on a stable, level, heat-resistant surface. Keep away from areas that can be damaged by steam (such as walls or cupboards).

Note: Leave 5 inches / 13 cm of space above the pressure cooker. [Figure 2.1]

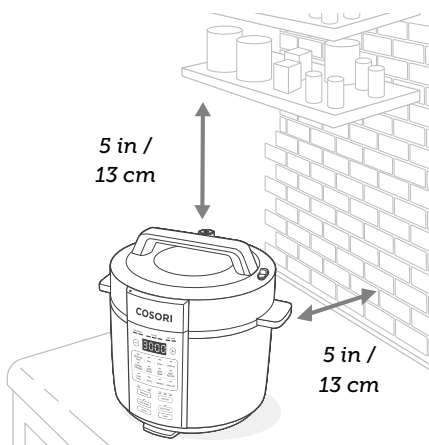

Figure 2.1

3. Twist the pressure cooker lid counterclockwise and lift to open. Remove the inner pot from the pressure cooker.
4. Make sure that the sealing ring is fit snugly inside the lid.

5. Remove the inner pot. Wipe the heating element with a soft, dry cloth to make sure it's clear of debris. [Figure 2.2]

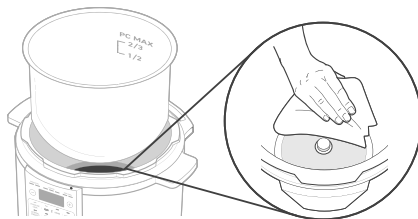

Figure 2.2

6. Wash the inner pot, accessories, and inside the lid using a non-abrasive sponge with water and a mild detergent, then dry thoroughly. See **Care & Maintenance**, page 27.
7. Insert the inner pot back into the pressure cooker base.
8. Plug into a kitchen outlet. [Figure 2.3]

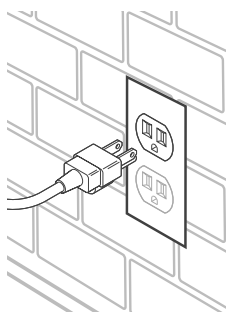

Figure 2.3

9. Before cooking, complete a **Test Run** (see page 17).

Test Run

Make sure you perform a Test Run before using your pressure cooker. This will help you learn how to use the cooker, and make sure it's working properly.

1. Make sure the inner pot is clean and empty.
2. Add 3 cups / 750 mL of water to the inner pot. **[Figure 3.1]**



Figure 3.1

3. Place the lid on the pressure cooker and turn clockwise to secure. The pressure cooker will make a sound to indicate the lid is locked. **[Figure 3.2]**



Figure 3.2

4. Select **PRESSURE COOK** and press the **-** or **+** buttons to set the cook time for 5 minutes. **[Figure 3.3]**



Figure 3.3

5. Press **PRESSURE** to select HIGH pressure.
6. Press **KEEP WARM** to turn off automatic KEEP WARM.

Note: KEEP WARM is on by default.

7. Press **START** to begin cooking. The pressure cooker will beep once, then start pre-heating. The progress bar will light up under **'PREHEATING'** and the display will show **[0000]**.
8. Once done preheating, the progress bar will light up under **'COOKING'** and the timer countdown will begin.
9. When the test run ends, the display will show **'End'** and the pressure cooker will beep 5 times to indicate cooking is finished.
10. The pressure cooker will begin to naturally release the pressure. Once the pressure has been completely released, the float valve will drop.
 - Optionally, you can quick release or timed natural release the pressure before opening the lid. See **Releasing Pressure** (page 14).
 - The lid will unlock when the float valve drops down.
11. Twist the lid counterclockwise. The pressure cooker will make a sound to indicate the lid is unlocked. Lift to remove. **[Figure 3.4]**



Figure 3.4

12. Use oven mitts to carefully remove the inner pot. Discard the water.
13. Allow the inner pot to cool, then dry using a soft towel.

Note: All pressure cookers may have a plastic smell from the manufacturing process. This is normal. If the plastic smell does not decrease after a test run, contact **Customer Support** (see page 34).

COOKING FUNCTIONS

Cooking functions are programmed with an ideal time and temperature for cooking certain foods.
(The preset cooking time does not include the preheating time, and the preheating time is not shown on the display.)

Cooking Functions Reference Chart (Pressure Cooking)

Cooking Function	Pressure Setting	Time Range	Default Time
Pressure Cook	Low	00:01–04:00	00:35
	High		
Rice	Low	00:01–01:00	00:12
	High		
Steam	Low	00:01–04:00	00:10
	High		
Sterilize	Low	00:01–01:00	00:30
	High		
Oatmeal/Porridge	Low	00:01–01:00	00:20
	High		
Stew/Broth	Low	00:01–04:00	00:30
	High		
Bean/Grain	Low	00:01–01:00	00:30
	High		
Meat/Poultry	Low	00:01–04:00	00:35
	High		

Cooking Functions (Cont.)

Cooking Functions Reference Chart (Non-Pressure Cooking)

Cooking Function	Temperature Setting	Time Range	Default Time
Slow Cook	Low-212 °F	00:05–24:00	06:00
	High-212 °F		
Sauté	Low-284 °F	00:01–01:00	00:30
	High-356 °F		
	Cus-248~356 °F		
Ferment	Low-91 °F	00:05–99:30	08:00
	High-108 °F		
	Cus-77~185 °F		
Sous Vide	Cus-77~194 °F	00:05–99:30	03:00
Manual Keep Warm	Low-149 °F	00:30–12:00	12:00
	High-174 °F	00:30–12:00	12:00

Auto Keep Warm temperature is 163°F

Note: Keep Warm is not available for Sauté, Sous Vide, or Ferment cooking functions.

Customize Cooking Function Settings

To customize a cooking function's time, follow the steps below.

1. Select a cooking function.
2. Press the - and + buttons to adjust the time.
3. Press **START**.

To customize a cooking function's temperature, follow the steps below.

1. Select a cooking function.
2. Select **TEMP SET**.
3. Press the cooking function's button again, and use the - and + buttons to adjust the temperature.
4. Press **START**.

Note: When you change a cooking function's settings, the pressure cooker will remember the new settings even if the pressure cooker has been unplugged. See **Reset Customized Cooking Functions** (page 24) to reset customized cooking functions.

Pressure Cook

Pressure cooking creates steam from liquid to cook food. To create steam, use broth, stock, soup, or juice.

CAUTION: Avoid recipes that call for more than ¼ cup / 60 mL of oil or fat content as using hot oil during pressure cooking may cause burns.

1. Twist the lid counterclockwise and lift to remove. Add the ingredients to the inner pot. [Figure 4.1]

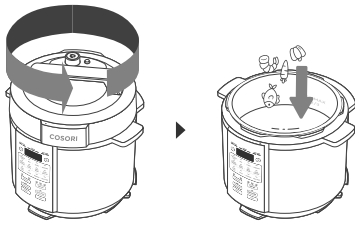

Figure 4.1

2. Close the lid on the pressure cooker and turn clockwise to secure. [Figure 4.2]



Figure 4.2

3. Select **PRESSURE COOK** and press the – or + buttons to adjust the time. [Figure 4.3]



Figure 4.3

4. Press **PRESSURE** to select **LOW** or **HIGH** pressure.
5. You can press **KEEP WARM** to turn off automatic Keep Warm.

Note: Keep Warm is on by default.

6. To delay cooking, press **DELAY START**. Then press the – or + buttons to adjust the delay start timer.
7. Press **START** to begin cooking. The pressure cooker will beep once, then start cooking.
8. When the cooking function ends, the pressure cooker will beep 5 times.
9. Push the steam release switch to '**Vent**' to quick release the pressure. Optionally, you can use one of the other forms of pressure releasing. See **Releasing Pressure**, page 14.
10. The float valve will drop to indicate when the pressure has been fully released. [Figure 4.3]

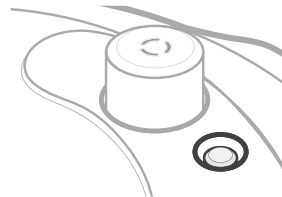

Figure 4.3

11. Twist the lid counterclockwise and lift to open. [Figure 4.4]



Figure 4.4

See the **Rice/Grains Quick Reference Chart** below for grain to water ratios when pressure cooking.

RICE/GRAINS QUICK REFERENCE CHART

Rice and Grain	Grain to Water Ratio
White Rice	1 : 1 $\frac{1}{8}$
Brown Rice	1 : 1 $\frac{1}{4}$
Quick Oats	1 : 3
Porridge	1 : 5
Quinoa	1 : 1 $\frac{1}{4}$

Slow Cook

Slow Cook lets you use your pressure cooker like any slow cooker. You can program Slow Cook for up to 24 hours of cook time.

1. Twist the lid counterclockwise and lift to open. Add the ingredients to the inner pot. [Figure 5.1]

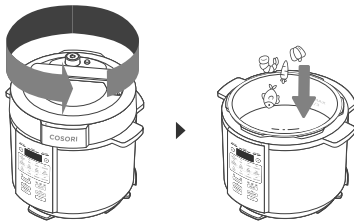

Figure 5.1

2. Close the lid on the pressure cooker and turn clockwise to secure. Move the steam release switch to 'Vent'.
3. Select **SLOW COOK** and press the – or + buttons to adjust the time if necessary. [Figure 5.2]

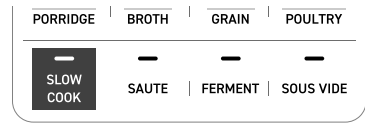

Figure 5.2

4. Press **TEMP SET** to select a **LOW** or **HIGH** temperature. [Figure 5.3]



Figure 5.3

5. You can press **KEEP WARM** to turn off automatic Keep Warm.
- Note:** Keep Warm will be on by default.
6. To delay cooking, press **DELAY START**. Then press the – or + buttons to adjust the delay start timer.
 7. Press **START** to begin cooking. The pressure cooker will beep once, then start.
 8. When the cooking function ends, the pressure cooker will beep 5 times.
 9. Twist the lid counterclockwise and lift to open.

Sauté

Sauté can replace a frying pan or grill and sear foods. Sauté can also prepare food for recipes that call for a pressurized cooking function.

1. Twist the lid counterclockwise and lift to remove. **Do not** use the pressure cooker lid when using the **SAUTE** cooking function. [Figure 6.1]

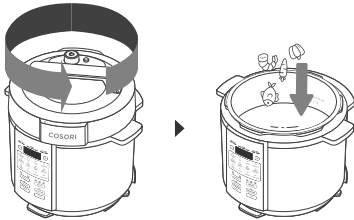

Figure 6.1

2. Select **SAUTE** and press the **-** or **+** buttons to adjust the time. [Figure 6.2]

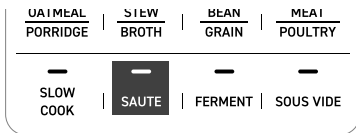

Figure 6.2

3. Press **TEMP SET** to select a **LOW**, **HIGH**, or **CUS** (custom) cook temperature.
 - a. If you select **CUS**, select **SAUTE** again, then press the **-** or **+** buttons to adjust the temperature.
4. Press **START** to begin cooking. The pressure cooker will beep once, then start.
5. When the display says 'HOT' with **3 beeps**, add the ingredients to the inner pot. [Figure 6.3]

HOT

Figure 6.3

6. When the selected cook time is done, the cooker will beep 5 times. Optionally, press **CANCEL** to stop the **SAUTE** cooking function before the cook time finishes.

Note: Delay Start and Keep Warm are not available for the 'Sauté' cooking function.

Ferment

Ferment can make yogurt using a 2-step process: heating milk to pasteurize it, and culturing the yogurt.

STEP 1: HEATING THE MILK

1. Twist the lid counterclockwise and lift to open. Add the milk to the inner pot. [Figure 7.1]

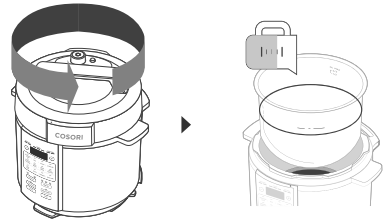

Figure 7.1

2. Close the lid on the pressure cooker and turn clockwise to secure. The pressure cooker will make a sound to indicate the lid is locked.
3. Move the steam release switch to 'Vent'.
4. Select **FERMENT** and press the **-** or **+** buttons to adjust the time to 35 minutes (00:35). [Figure 7.2]



Figure 7.2

5. Press **TEMP SET** to select **CUS** (custom) cook temperature.
6. Select **FERMENT** again, then press the **-** or **+** buttons to adjust the temperature to 161°F.
7. Press **START** to begin cooking. The cooker will beep once, then start.
8. Open the lid and check the temperature of the milk after 15 minutes. If the milk has reached 161°F, press **CANCEL**. If not, let the milk continue to ferment until it reaches 161°F.
9. Carefully remove the inner pot and allow the milk to cool to 110°F, then place the pot back into the pressure cooker.

Note: To cool down the milk faster, place the inner pot in an ice bath.

STEP 2: CULTURING THE YOGURT

10. Reserve 1 cup of the 110°F milk and place into a large bowl, then add 4 tablespoons of plain yogurt and stir to combine.
11. Add the yogurt milk mixture back into the inner pot with the rest of the milk.
12. Close the lid on the pressure cooker and turn clockwise to secure. Move the steam release switch to **'Vent'**.
13. Select **FERMENT** and press the **-** or **+** buttons to adjust the time to 10 hours (10:00). **[Figure 7.3]**



Figure 7.3

14. Press **TEMP SET** to select **CUS** (custom) cook temperature.
15. Select **FERMENT** again, then press the **-** or **+** buttons to adjust the temperature to 110°F.

16. Press **START** to begin cooking. The pressure cooker will beep once, then start.
17. When the cook time has finished and the cooker has beeped, open the lid carefully and check if the yogurt has set. To do this, gently nudge the inner pot to see if the yogurt jiggles all together with no separation. If the yogurt is loose, continue to ferment for another 1 to 2 hours.
18. Remove the inner pot and cool to room temperature without stirring, about 2 hours. After the yogurt has cooled, cover the pot with plastic wrap and let it chill for 6 hours in the refrigerator.
19. Stir the chilled yogurt until completely smooth.
20. Store the yogurt in airtight containers of your choice—glass jars are recommended—for up to 2 weeks if unopened. Once a container is opened, use within 7 days.

Note: Delay Start and Keep Warm are not available for the 'Ferment' cooking function.

Sous Vide

Sous Vide is a method of cooking meat or fish in a vacuum-sealed, food-safe bag submerged in water. You'll need tongs, a thermometer, and a resealable or vacuum-sealed, food-safe plastic bag.

1. Twist the lid counterclockwise and lift to open.
2. Fill the inner pot with water to the **"-1/2"** line. **[Figure 8.1]**

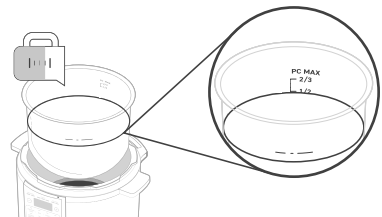

Figure 8.1

- Close the lid on the pressure cooker and turn clockwise to secure. Move the steam release switch to 'Vent'.
- Select **SOUS VIDE** and press the **-** or **+** buttons to adjust the time. [Figure 8.2]

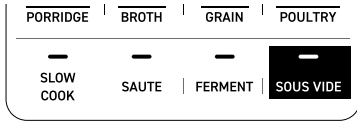

Figure 8.2

- Press **TEMP SET** to select **CUS** (custom) cook temperature.
- Select **SOUS VIDE** again, then press the **-** or **+** buttons to adjust the temperature.
- Press **START** to begin cooking. The pressure cooker will beep once, then start.
- While the cooker is preheating, prepare your meat or fish in a vacuum-sealed, food-safe bag.
- When the progress bar shows **COOKING** stage, remove the lid and carefully submerge the food in the inner pot. [Figure 8.3]

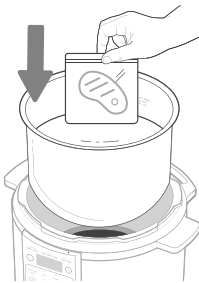

Figure 8.3

Note: Add more water if the meat or fish is not fully submerged. Make sure the seal of the bag is above the water line.

- Close and secure the lid.
- When the cooking function ends, the display will show **End** and the pressure cooker will beep 5 times.

Note: Delay Start and Keep Warm are not available for the 'Sous Vide' cooking function.

Delay Start

Delay Start lets you add ingredients now, but cook later.

- Select a cooking function and adjust the cook time, temperature, and pressure level as needed.
- Select **DELAY START**.
- Press the **-** or **+** buttons to adjust the delay start timer from 10 minutes (00:10) to 24 hours (24:00). [Figure 9.1]

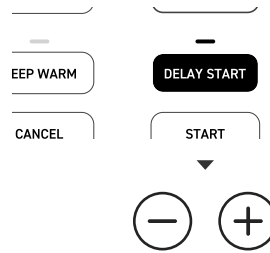

Figure 9.1

- Press **START**. The cooking function will start when the delay start timer is finished.

Note: Delay Start is not available when using the 'Sauté', 'Ferment', and 'Sous Vide' cooking functions.

Keep Warm

Keep Warm can be used to keep cooked food warm or reheat food.

- Place food into the inner pot.
- Close the lid on the pressure cooker and turn clockwise to secure. Move the steam release switch to 'Vent'. [Figure 9.2]

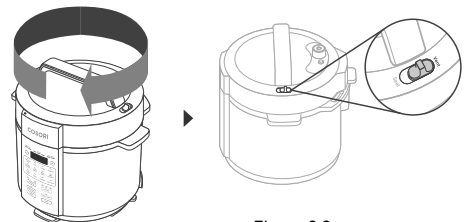

Figure 9.2

3. Select **KEEP WARM** and press the **-** or **+** buttons to adjust the time for up to 12 hours. [Figure 9.3]

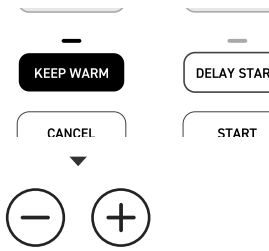

Figure 9.3

4. Press **TEMP SET** to select a **LOW**, **HIGH**, or **CUS** (custom) cook temperature.
 - a. If you select **CUS**, select **KEEP WARM** again, then press the **-** or **+** buttons to adjust the temperature.
5. When warming thick or starchy foods, stir the food every 40 to 60 minutes to ensure even heating.

Note: When warming thick or starchy foods, stir the food every 40 to 60 minutes to ensure even heating.

6. Press **START** to begin warming. The pressure cooker will beep once, then start.
7. When the timer is finished, warming will stop, and the display will show **END**.

Note: Keep Warm is not available when using the 'Sauté', 'Ferment', and 'Sous Vide' cooking functions.

Sterilize

Sterilize can be used to disinfect glass, silicone, and metal household items. Do not sterilize industrial equipment in the pressure cooker.

1. Add 2 cups / 500 mL of water into the inner pot.
2. Insert the steam rack and place items on the steam rack. [Figure 9.4]

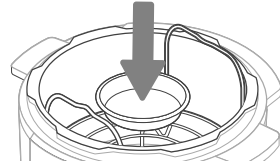

Figure 9.4

1. Close the lid and turn clockwise to secure.
2. Select **STERILIZE** and press the **-** or **+** buttons to adjust the time if desired. [Figure 9.5]

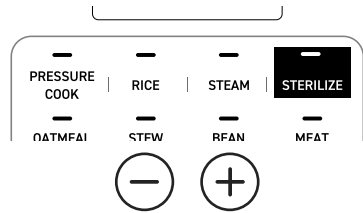

Figure 9.5

Note: The default sterilize time is 30 minutes (00:30).

3. Press **PRESSURE** to select **LOW** or **HIGH** pressure.
4. Press **START** to begin sterilizing. The pressure cooker will beep once, then start.
5. When the cooking function ends, the pressure cooker will beep 10 times.
6. Push the steam release switch to **Vent** to quick release the pressure.
7. The float valve will drop to indicate when the pressure has been fully released. [Figure 9.6]

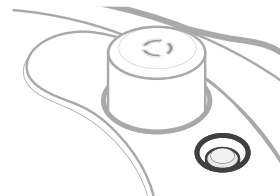



Figure 9.6

1. Twist the lid counterclockwise and lift to open.
2. Use oven mitts or tongs to safely remove the hot, sterilized items and allow to cool on a heat-resistant surface.
3. Allow the inner pot to cool before removing the steam rack and any remaining water from the inner pot.

Reset Customized Cooking Functions

The pressure cooker will remember cook time, temperature, and pressure level of adjusted cooking function settings until you reset the settings.

To reset a single cooking function:

1. When in standby, press and hold the desired cooking function you want to reset.
2. The display will show  and the cooking function's settings will return to the default setting.

To reset all cooking functions:

1. When in standby, press and hold **CANCEL** until the pressure cooker beeps.
2. All cooking function settings will reset and return to their default settings.

CARE & MAINTENANCE

Clean your pressure cooker, inner pot, steam rack, and lid after every use.

Your pressure cooker has a stainless steel, fingerprint-resistant housing for easy cleaning.

Note:

- **Do not** use abrasive cleaners, metal scouring pads, or metal utensils on any part of the pressure cooker and accessories, including the inner pot. These will scratch or damage their surfaces.
- This pressure cooker contains no user-serviceable parts. Any repairs should be performed by an authorized service representative. Contact **Customer Support** (see page 34).

Cleaning the Pressure Cooker Base

1. Before cleaning, unplug the pressure cooker and allow to cool completely. Remove the lid for faster cooling.
 - **Do not** wash or dry the pressure cooker base in a dishwasher.
2. Wipe the inside and outside of the cooker with a clean, damp cloth.
 - **Do not** immerse the pressure cooker base in water.
 - **Do not** spray water inside the cooker. **[Figure 10.1]**

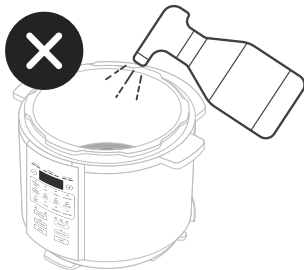

Figure 10.1

3. Remove the inner pot. Wipe the heating element with a soft, dry cloth to make sure it's clear of debris.
4. Let all surfaces dry completely before using the pressure cooker. **Always** make sure the heating element inside the pressure cooker is dry before using.

Cleaning the Inner Pot, Lid, Lid Parts, and Steam Rack

Note:

- We recommend hand washing the inner pot, lid, lid parts, sealing ring, and steam rack.
- The inner pot, lid, lid parts, and steam rack can be washed in the top rack of the dishwasher, but may wear more quickly over time.

1. Allow the inner pot, lid, lid parts, and steam rack to cool completely. Wipe away any leftover food residue.
2. Apply soap and water to a soft, damp sponge. Wash the inner pot and steam rack and soak in warm, soapy water if necessary.
3. Clean the inside of the lid. Make sure to remove any food debris from the anti-block shield and sealing ring. **Do not** submerge lid in water.
4. If necessary, the parts inside the lid can be removed for cleaning. These parts are small and easy to lose, so be careful.
 - a. Remove the sealing ring by pulling the edge of the silicone out of the sealing ring rack and wipe clean. Replace the sealing ring by pressing it firmly in to the sealing ring rack to prevent warping. The sealing ring should fit snugly inside the sealing ring rack and shouldn't fall out when lifting the lid.

- b. Remove the anti-block shield by gripping it from either side, then pulling it up. **[Figure 10.2]** Rinse and dry the anti-block shield and replace it inside the lid.

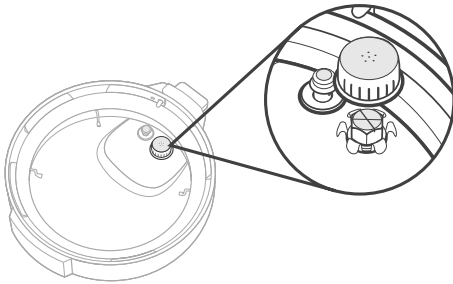

Figure 10.2

- c. Remove the silicone cap from the float valve. The float valve may drop out unexpectedly without the silicone cap, so remove carefully. **[Figure 10.3]**

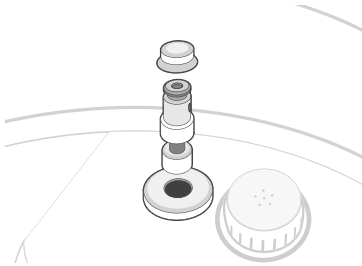

Figure 10.3

- d. Rinse both parts with clean water, and secure the float valve back onto the lid using the float valve silicone cap. **[Figure 10.4]**

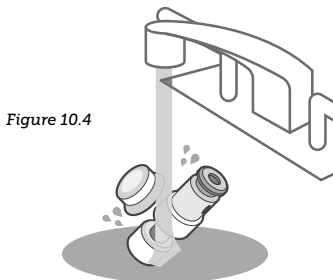

Figure 10.4

5. Dry thoroughly.
6. **Always** replace the inner pot into the pressure cooker before plugging in or turning on.
 - a. Make sure the bottom outside of the inner pot is **dry** before placing into the pressure cooker.

Cleaning the Condensation Collector

1. Remove the condensation collector by gripping each side with your thumb and pointer finger and pulling away from the pressure cooker. **[Figure 10.5]**

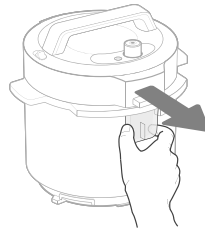

Figure 10.5

Note: Do not pull down on the condensation collector.

2. Hand wash the condensation collector with soap and water or in the top rack of a dishwasher. Dry thoroughly.
3. Replace the condensation collector. **[Figure 10.6]**

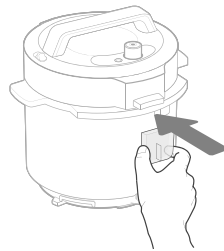

Figure 10.6

Note: Always replace the condensation collector before cooking in the pressure cooker. Do not use the pressure cooker without the condensation collector in place.

Cleaning the Sealing Ring

1. Remove the sealing ring by pulling the edge of the silicone out of the sealing ring rack. **[Figure 10.7]**

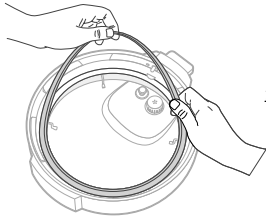

Figure 10.7

Note: Make sure the sealing ring does not have any warping or tears. If the sealing ring is damaged, contact **Customer Support** (page 34).

2. Hand wash the sealing ring with soap and water or in the top rack of a dishwasher. Dry thoroughly. **[Figure 10.8]**



Figure 10.8

3. Replace the sealing ring by pressing it firmly into the sealing ring rack to prevent warping. The sealing ring should fit snugly inside the sealing ring rack and shouldn't fall out when lifting the lid. **[Figure 10.9]**

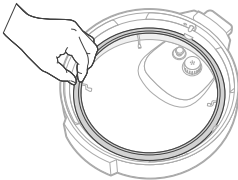

Eliminating Lingering Odor

1. Make sure all lid parts are installed in the lid. See **Cleaning the Inner Pot, Lid, Lid Parts, and Steam Rack** (page 27).

2. Add 1 cup / 250 mL of water and 1 cup / 250 mL of vinegar to the inner pot.
3. Select **PRESSURE COOK** and press the – or + buttons to adjust the time to 5–10 minutes.
4. Press **START** to begin cooking. The pressure cooker will beep once, then start cooking.
5. When the cooking function ends, the pressure cooker will beep 10 times.
6. Push the steam release switch to **'Vent'** to quick release the pressure.

Note: The float valve will drop to indicate when the pressure has been fully released.

7. Twist the lid counterclockwise and lift to open.
8. Use oven mitts to carefully remove the inner pot. Discard the water and vinegar mixture.
9. Allow the inner pot to cool, then dry using a soft towel.

Storage

1. Clean and dry the pressure cooker and all parts.
2. Place the inner pot and steam rack into the pressure cooker. Close the pressure cooker lid and twist to secure into place.
3. Wrap the power cord clockwise around the base of the pressure cooker so that it sits securely in the cord housing. **[Figure 10.10]**

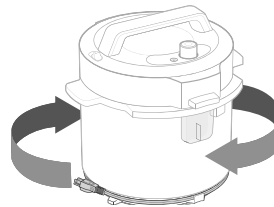

Figure 10.10

4. Store the pressure cooker in an upright position. **Do not** store anything on top.

TROUBLESHOOTING

Problem	Possible Solution
Steam leaks from the side of the lid.	The sealing ring may be missing or not secure. Open the lid and firmly press on the sealing ring to secure in the sealing ring rack. See Care & Maintenance (page 27).
	Food debris may be stuck to the sealing ring. Clean the sealing ring. See Care & Maintenance (page 27).
	The lid is not properly closed. Open and close the lid, and make sure the lid is locked in place. See Pressure Cooker Lid (page 12).
	The sealing ring may be warped or broken. Contact Customer Support (see page 34).
	The inner pot's rim may be warped. Contact Customer Support (see page 34).
There is an occasional clicking sound.	The bottom outside of the inner pot may be wet. Dry the exterior of the inner pot.
	The pressure board may be switching when temperature is increasing inside the pressure cooker. This is normal.
The lid is difficult to close and secure.	The sealing ring may not be properly installed. Open the lid and firmly press on the sealing ring to secure in the sealing ring rack. See Care & Maintenance (page 27).
	The float valve may be stuck in the up position. Push the float valve down with a long utensil.
The inner pot is stuck to the lid or the lid is difficult to remove.	Move the steam release switch to 'Vent' position to allow any pressure to be released and open the lid.
	Release any pressure (see page 14) and gently tap the steam release valve with a long utensil. Open the lid and clean the float valve and surrounding area before using the pressure cooker again.
The float valve does not rise.	There may be food debris on the float valve or float valve silicone cap. Clean the float valve and cap thoroughly and perform a test run. See Care & Maintenance (page 27).
	There may not be enough liquid in the inner pot. Add liquid to the inner pot if necessary, and check for scorching on the bottom of the inner pot.
	The float valve may be obstructed by the lid-locking mechanism. Tap the float valve with a long utensil. If the float valve does not drop, turn the pressure cooker off and contact Customer Support (see page 34).
	The inner pot, float valve, silicone cap, or heating element may be damaged or missing. Contact Customer Support (see page 34).
Small amounts of steam leak or hiss from the steam release valve during the cooking cycle.	The steam release switch may be in the 'Vent' position. Move the switch to 'Seal' .
	The pressure cooker may be regulating excess pressure. This is normal.

TROUBLESHOOTING (CONT.)

<p>The display is blank after connecting the pressure cooker to a power outlet.</p>	<p>The plug may not be fully connected to the pressure cooker, or to the power outlet. Make sure the plug is secure. If the plug is damaged, contact Customer Support (see page 34).</p>
	<p>The outlet may not have power. Try a different outlet.</p>
	<p>The pressure cooker's fuse may have blown. Contact Customer Support (see page 34).</p>
<p>Steam gushes from the steam release valve when the steam release switch is in the 'Seal' position.</p>	<p>There may not be enough liquid in the inner pot. Add liquid if necessary.</p>
	<p>The pressure sensor may not be properly working. Contact Customer Support (see page 34).</p>
	<p>The steam release valve may not be properly sealed. Safely move the steam release switch to 'Vent' and back to 'Seal'.</p>
<p>Error code "E1", "E2", "C6H", or "C6L" shows on the display.</p>	<p>The pressure sensor may be faulty. Contact Customer Support (see page 34).</p>
<p>Error code "C7" or "NoPr" shows on the display.</p>	<p>The heating element may not be working. Contact Customer Support (see page 34).</p>
	<p>There may not be enough liquid in the inner pot. Add liquid if necessary.</p>
	<p>The steam release switch may not be in the 'Seal' position.</p>
<p>Error code "Lid" shows on the display.</p>	<p>The lid may not be completely sealed. Remove the lid and replace the lid, and make sure it is secure. See Pressure Cooker Lid (page 12).</p>
	<p>If 'Saute' cooking function is selected, remove the lid. Do not use the pressure cooker lid with the 'Saute' cooking function.</p>
<p>Error code "PrSE" shows on the display.</p>	<p>Pressure has accumulated during a non-pressurized cooking function. Move the steam release switch to the 'Vent' position, or remove the lid if the lid is not needed.</p>
<p>Error code "Food burn" shows on the display.</p>	<p>There may not be enough liquid in the inner pot. Make sure the float valve is in the down position and the pressure is released. Open the lid to inspect the bottom of the inner pot.</p>
	<p>High temperature may be detected at the bottom of the inner pot. The pressure cooker will automatically lower the temperature to prevent overheating.</p>
	<p>Starch deposits at the bottom of the inner pot may have caused uneven heating. Turn the pressure cooker off, release the pressure accordingly, and inspect the bottom of the inner pot.</p>

If your problem is not listed, please contact **Customer Support** (see page 34).

FEDERAL COMMUNICATION COMMISSION INTERFERENCE STATEMENT - PART 15

This device complies with Part 15 of the FCC Rules. Operation is subject to the following two conditions:

1. This device may not cause harmful interference, and
2. This device must accept any interference received, including interference that may cause undesired operation.

NOTE: This equipment has been tested and found to comply with the limits for a Class B digital device, pursuant to Part 15 of the FCC Rules. These limits are designed to provide reasonable protection against harmful interference in a residential installation. This equipment generates, uses and can radiate radio frequency energy and, if not installed and used in accordance with the instructions, may cause harmful interference to radio communications. However, there is no guarantee that interference will not occur in a particular installation. If this equipment does cause harmful interference to radio or television reception, which can be determined by turning the equipment off and on, the user is encouraged to try to correct the interference by one or more of the following measures:

- Reorient or relocate the receiving antenna.
- Increase the separation between the equipment and receiver.
- Connect the equipment into an outlet on a circuit different from that to which the receiver is connected.
- Consult the dealer or an experienced radio/TV technician for help.

FCC Caution: Any changes or modifications not expressly approved by the party responsible for compliance could void the user's authority to operate this equipment.

FCC SDOC SUPPLIER'S DECLARATION OF CONFORMITY

Arovast Corporation hereby declares that this equipment is in compliance with FCC requirements.

The declaration of conformity may be consulted in the support section of our website, accessible from www.cosori.com

WARRANTY INFORMATION

Product	6.0-Quart Pressure Cooker
Model	CMC-CO601-SUS
<i>For your own reference, we strongly recommend that you record your order ID and date of purchase.</i>	
Date of Purchase	
Order ID	

TERMS & POLICY

Arovast Corporation ("Arovast") warrants this product to the original purchaser to be free from defects in material and workmanship, under normal use and conditions, for a period of 2 years from the date of original purchase.

Arovast agrees, at our option during the warranty period, to repair any defect in material or workmanship or furnish an equal product in exchange without charge, subject to verification of the defect or malfunction and proof of the date of purchase.

There is no other express warranty. This warranty does not apply:

- If the product has been modified from its original condition;
- If the product has not been used in accordance with directions and instructions in the user manual;
- To damages or defects caused by accident, abuse, misuse or improper or inadequate maintenance;
- To damages or defects caused by service or repair of the product performed by an unauthorized service provider or by anyone other than Arovast;
- To damages or defects occurring during commercial use, rental use, or any use for which the product is not intended;
- To damages or defects exceeding the cost of the product.

Arovast will not be liable for indirect, incidental, or consequential damages in connection with the use of the product covered by this warranty.

This warranty extends only to the original consumer purchaser of the product and is not transferable to any subsequent owner of the product regardless of whether the product is transferred during the specified term of the warranty.

This warranty does not extend to products purchased from unauthorized sellers. Arovast's warranty extends only to products purchased from authorized sellers that are subject to Arovast's quality controls and have agreed to follow its quality controls.

All implied warranties are limited to the period of this limited warranty.

This warranty gives you specific legal rights and you may also have other rights which vary from state to state. Some states do not allow the exclusion or limitation of incidental or consequential damages, so the above limitation or exclusion may not apply to you.

If you discover that your product is defective within the specified warranty period, please contact Customer Support via support@cosori.com. **DO NOT** dispose of your product before contacting us. Once our Customer Support Team has approved your request, please return the product with a copy of the invoice and order ID.

Every COSORI product automatically includes a 2-year warranty. To make the customer support process quick and easy, register your product online at www.cosori.com/warranty

This warranty is made by:

Arovast Corporation
1202 N. Miller St., Suite A
Anaheim, CA 92806

CUSTOMER SUPPORT

If you have any questions or concerns about your new product, please contact our helpful Customer Support Team.

Arovast Corporation

1202 N. Miller St., Suite A
Anaheim, CA 92806

Email: support@cosori.com

Toll-Free: 1-888-402-1684

Support Hours

Mon–Fri, 9:00 am–5:00 pm PST/PDT

**Please have your invoice and order ID ready before contacting Customer Support.*

MORE COSORI RECIPES

Considering what to cook? Many recipe ideas are available, both from us and the COSORI community.



**Scan the QR code
to get the app.**

COSORI®

Questions or Concerns?

Mon-Fri, 9:00 am-5:00 pm PST/PDT
support@cosori.com | 1-888-402-1684