

COSORI®

User Manual

13-Quart Air Fryer Oven

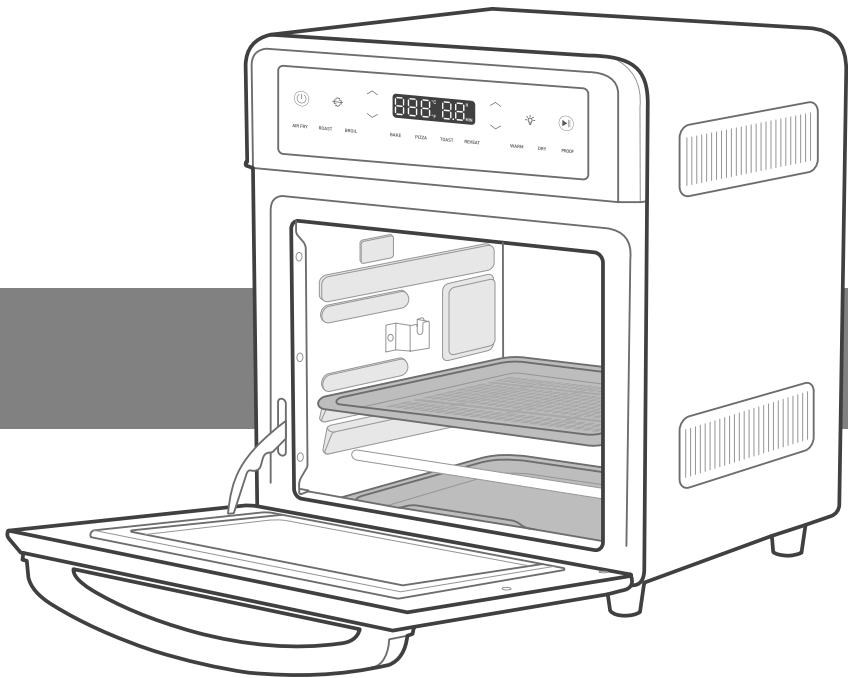

Questions or Concerns?

Mon-Fri, 9:00 am-5:00 pm PST/PDT
support@cosori.com | (888) 402-1684



Thank you for
your purchase!



(We hope you love your new air fryer oven as much as we do)



join

the COSORI Cooks Community on Facebook
[facebook.com/groups/cosoricooks](https://www.facebook.com/groups/cosoricooks)



explore

our recipe gallery
www.cosori.com/recipes



enjoy

weekly, featured recipes
made exclusively by our in-house chefs



CONTACT OUR CHEFS

Our helpful, in-house chefs are ready to assist you with any questions you might have!

Email: recipes@cosori.com

Toll-Free: (888) 402-1684

Mon-Fri, 9:00 am–5:00 pm PST/PDT

On behalf of all of us at COSORI,

Happy cooking!

Table of Contents

Specifications	3
Package Contents	3
Important Safeguards	4
Getting to Know Your Air Fryer Oven	8
Display	9
Controls	10
Before First Use	12
Cooking with Your Air Fryer Oven	12
Cooking Functions Quick Reference Guide	15
Care & Maintenance	27
Troubleshooting	28
Warranty Information	30
Customer Support	31

Package Contents

1 x Air Fryer Oven
1 x Food Tray
1 x Air Fryer Tray
1 x Drip Tray
1 x Rotisserie Basket
1 x Rotisserie Fork Set
1 x Rotisserie Handle
1 x Recipe Book
1 x User Manual
1 x Quick Reference Guide

Specifications

Model	CAF-R121-SUS
Power Supply	AC 120V, 60Hz
Rated Power	1800W
Capacity	Approx. 13 qt / 12 L, 8.5" Pizza
Temperature Range	90°–450°F / 30°–230°C
Time Range	0–12 hr
Weight	15.4 lb / 7 kg (including accessories)
Dimensions	14.2 x 13.0 x 14.6 in / 36.0 x 33.0 x 37.0 cm

Download the free VeSync app to access original recipes and video tutorials from the COSORI chefs, interact with our online community, and more!



READ AND SAVE THESE INSTRUCTIONS

IMPORTANT SAFEGUARDS

Follow basic safety precautions when using your air fryer oven.
Read all instructions.

Key Safety Points

- **Do not** touch hot surfaces. Use handle.
- The outside of the air fryer, including the door, is hot during and after use.
- **Always** use heat-resistant gloves, pads, or air fryer mitts when handling hot materials, and when placing items in or removing items from the air fryer, including trays, racks, accessories, or containers.
- **Do not** block any ventilation openings. Hot steam is released through openings. Keep your hands and face clear of openings.
- **Do not** use your air fryer if it is damaged, not working, or if the cord or plug is damaged. **Contact Customer Support** (see page 31).
- **Do not** use third-party replacement parts or accessories, as this may cause injuries.
- **Do not** use outdoors.
- **Do not** place the air fryer or any of its parts on a stove, near gas or electric burners, or inside a heated oven.
- Be extremely cautious when removing a tray, basket, or rack if it contains hot oil, grease, or other hot liquids.
- **Do not** clean with metal scouring pads. Metal fragments can break off the pad and touch electrical parts, creating a risk of electric shock.
- Clean the drip tray after using. Accumulated grease and crumbs can overheat and catch fire.

General Safety

- When the air fryer is not in use, and before cleaning, tap  to turn it off, then unplug from outlet. Allow to cool completely before putting on or taking off parts.
- To protect against electric shock, **do not immerse the air fryer**, cord, or plug in water or liquid.
- Close supervision is necessary when the air fryer is used by or near children.
- Children should be supervised to ensure that they **do not** play with the air fryer.
- **Do not** store anything on top of your air fryer while it is operating. **Do not** store anything inside your air fryer other than recommended accessories.
- The air fryer is not intended to be operated by means of an external timer or separate remote-control system.

- **Only** use as directed in this manual. Do not use air fryer for any purpose other than its intended use.
- This air fryer is not intended for use by persons (including children) with reduced physical, sensory, or mental capabilities, or lack of experience and knowledge, unless they have been given supervision or instruction concerning use of the air fryer by a person responsible for their safety.
- **Do not** allow children to clean or perform maintenance on the air fryer.
- Keep the air fryer and its cord out of reach of children.
- Not for commercial use. Household use **only**.

Note: See **Care & Maintenance** for instructions on how to clean accessories (page 27).

While Cooking

- To avoid risk of fire or electric shock, **do not** place oversized foods or metal utensils (except official COSORI accessories) into the air fryer.
- **Do not** place paper, cardboard, or non-heat-resistant plastic into your air fryer, or any materials which may catch fire or melt.
- To avoid overheating, **do not** use metal foil in the air fryer unless directed. Use extreme caution when using foil, and **always** fit foil as securely as possible. If the foil contacts the air fryer's heating elements, this can cause overheating and risk of fire.
- **Do not** cover the drip tray or any part of the air fryer with metal foil, except for the food tray and air fryer tray as directed.
- **Never** put baking or parchment paper into the air fryer without food on top. Air circulation can cause paper to move and touch heating elements.
- **Always** use heat-safe containers. Be extremely cautious if using containers that aren't metal or glass.
- Keep your air fryer away from flammable materials (curtains, tablecloths, walls, etc.). Use on a flat, stable, heat-resistant surface away from heat sources or liquids.
- Immediately turn off and unplug your air fryer if you see dark smoke coming out. Food is burning. Wait for smoke to clear before opening the air fryer door.
- When unplugging the air fryer, be cautious of hot surfaces.

Power & Cord

- This air fryer uses a short power-supply cord to reduce the risk of entangling or tripping.
- Your oven has a polarized plug (one prong is wider than the other), which fits into a polarized outlet only one way. If the plug does not fit, reverse the plug. If it still does not fit, **do not** use the plug in that outlet. **Do not** alter the plug in any way.
- **Do not** let the power cord (or any extension cord) hang over the edge of a table or counter, or touch hot surfaces.
- The cord should be arranged so that it will not drape over the countertop or tabletop where it can be pulled on by children or tripped over unintentionally.
- If the power supply cord is damaged, it must be replaced by Arovast Corporation or similarly qualified persons in order to avoid an electric or fire hazard. Please contact **Customer Support** (page 31).

Extension Cords

- Longer extension cords are available and may be used if care is exercised in their use.
- If a longer extension cord is used:
 - The marked electrical rating of the cord set or extension cord should be at least as great as the electrical rating of the oven.
 - The cord should be arranged so that it will not drape over the countertop or tabletop where it can be pulled on by children or tripped over unintentionally.

Electromagnetic Fields (EMF)

This air fryer complies with all standards regarding electromagnetic fields (EMF). If handled properly and according to the instructions in this user manual, the appliance is safe to use based on scientific evidence available today.

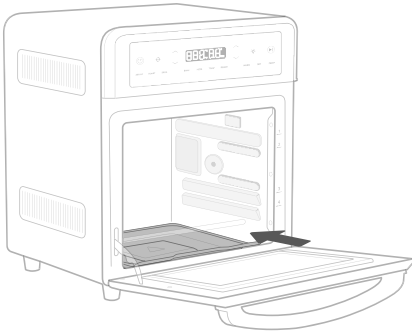

Place drip tray inside with handle facing out.

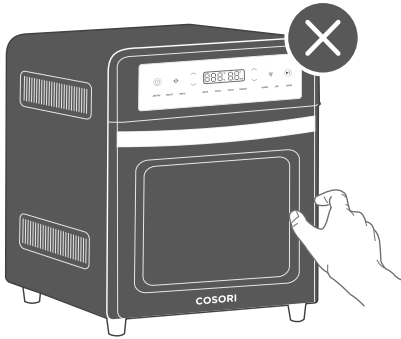

CAUTION: HOT

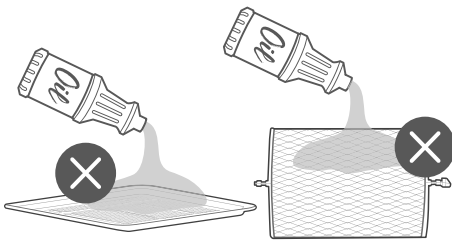

DO NOT fill with oil.
This is not a deep fryer.

SAVE THESE INSTRUCTIONS

GETTING TO KNOW YOUR AIR FRYER OVEN

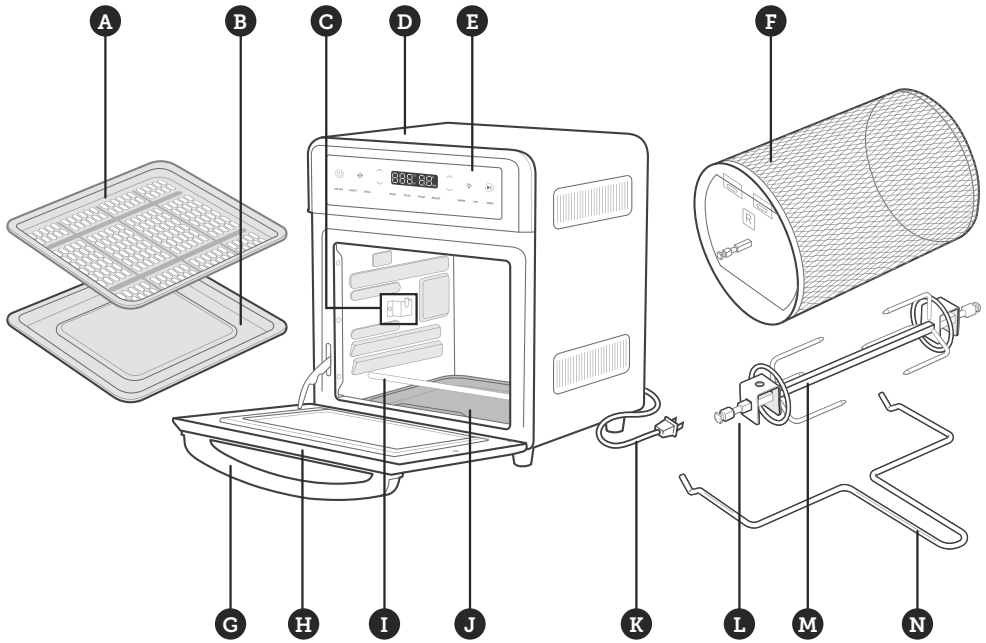

- A. Air Fryer Tray
- B. Food Tray
- C. Rotisserie Slots
- D. Housing
- E. LED Display

- F. Rotisserie Basket
- G. Handle
- H. Door
- I. Heating Elements
- J. Drip Tray

- K. Power Cord
- L. Rotisserie Fork Set
- M. Rotisserie Shaft
- N. Rotisserie Handle

DISPLAY

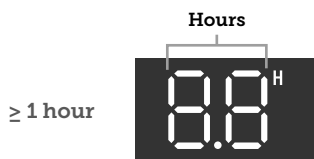
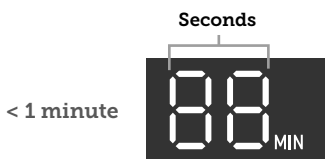
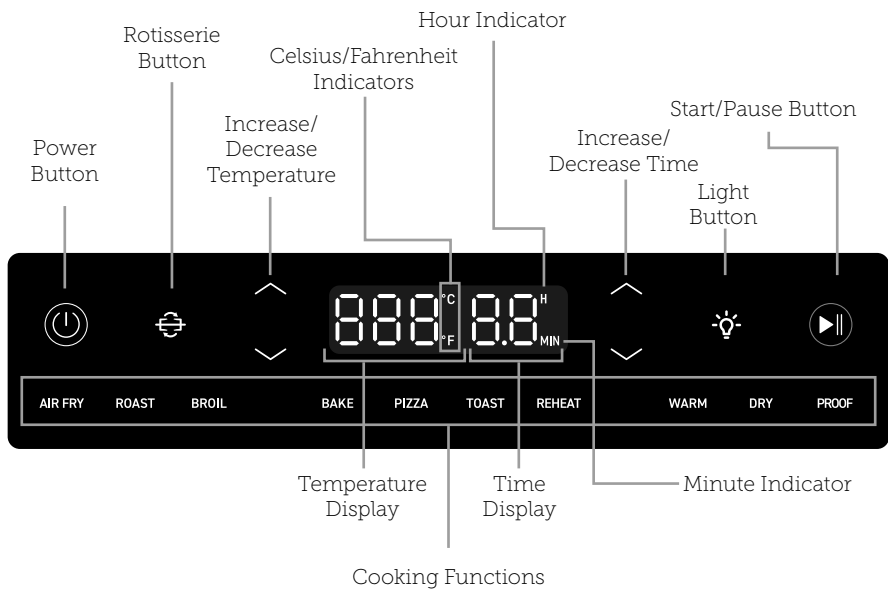

Cook Time Remaining	Display Format
< 1 minute	Seconds
< 1 hour	Minutes
≥ 1 hour	Hours

Status Messages

"PrE"	Air fryer is preheating*
"Add Food"	Air fryer is preheated and you can add food
"End"	Cooking function has ended
"L1-L7"	Indicates toast darkness level ranging from L1 to L7
"OPEN"	Door is open

*Preheating is automatically included in the Air Fry, Roast, Bake, and Pizza cooking functions.

CONTROLS

Power Button

- Tap to turn the air fryer on/off.
- While the air fryer is cooking or paused, tap to cancel cooking. The air fryer will return to standby.
- Press and hold for 10 seconds to reset the air fryer to factory settings and restore all default cooking function settings.





Light Button

- Tap to turn the interior light on/off.
- If not manually turned off, the light will turn off automatically after 1 minute.
- Light turns on when the door is opened and also in the last 30 seconds of a cooking function.





ROTISSERIE Button

- Tap to turn rotisserie rotation on/off.
- Rotisserie rotation is only available when using the Air Fry or Roast cooking functions.
- Rotation turns off automatically when a cooking function finishes.

Increase/Decrease Temperature

- Tap  and  to adjust the temperature setting.
- Temperature will adjust in increments of 5°F. Press and hold to adjust in increments of 10°F.
- Press and hold  and  at the same time for 5 seconds to switch temperature units from Fahrenheit to Celsius.

Increase/Decrease Time

- Tap  and  to adjust the time setting.
- Time will adjust in increments of 1 or 10 minutes, or 0.5 or 1 hour, depending on the cooking function (see chart).
- Press and hold to adjust time in higher increments (see chart).
- To turn selection sounds on/off, press and hold  and  at the same time for 5 seconds.

Note: You cannot turn off “press and hold” sounds or error alert sounds.

START/PAUSE Button

- Starts or pauses a cooking function.
- Tap during cooking to switch cooking functions.
- Tap during preheating to skip the preheating stage. Preheating is automatically included in the Air Fry, Roast, Bake, and Pizza cooking functions.

Note: When you open the air fryer door during cooking, the air fryer will pause cooking automatically, and the interior light will turn on. When you close the air fryer door, the air fryer will resume cooking and the interior light will turn off again.

Time Increment Chart

Air Fry, Roast, Broil, Bake, Pizza, Reheat, Warm	
All times (tap button)	1-minute increments
All times (press and hold button)	10-minute increments
Dehydrate	
< 10 hours (tap button)	0.5-hour increments
< 10 hours (press and hold button)	1-hour increments
≥ 10 hours	1-hour increments
Proof	
< 1 hour (tap button)	1-minute increments
< 1 hour (press and hold button)	10-minute increments
≥ 1 hour (tap button)	0.5-hour increments
≥ 1 hour (press and hold button)	1-hour increments
≥ 10 hours	1-hour increments

Note: Not all cooking functions can exceed 1 hour of cooking time.



BEFORE FIRST USE

Setting Up

1. Remove all packaging around and inside the air fryer.
2. Place on a stable, level, heat-resistant surface, away from anything that can be damaged by heat.
3. Wash all accessories and clean the air fryer's interior (see page 27). Dry and place accessories back in air fryer.

Test Run

A test run will help you become familiar with your air fryer, make sure it's working correctly, and clean it of possible residues.

1. Make sure there is no food or packaging in the oven and plug it in.
2. Tap **AIR FRY**, then tap  to begin preheating.
3. Tap  again to skip the preheating stage and the display will show the timer counting down.

Note: We recommend running the air fryer for 30–60 minutes during the test run.

4. The air fryer will stop heating and beep several times when finished.

COOKING WITH YOUR AIR FRYER OVEN

CAUTION:

- The outer surface of the air fryer, including the oven door, is hot during and after use. Temperature may be over 212°F. **Do not** touch hot surfaces. Use handle.
- **Always** use heat-resistant gloves, pads, or oven mitts when handling hot materials, and when placing items in or removing items from the air fryer.

Always make sure the drip tray is properly in place at the bottom of the air fryer when cooking. [Figure 1.1] The drip tray is not intended to cook food on.

Using the Trays

Three trays are included with your air fryer: the food tray, air fryer tray, and drip tray. The cooking functions require different trays, so make sure to use the correct tray. Follow the recipe instructions or the suggestions given in each function section.

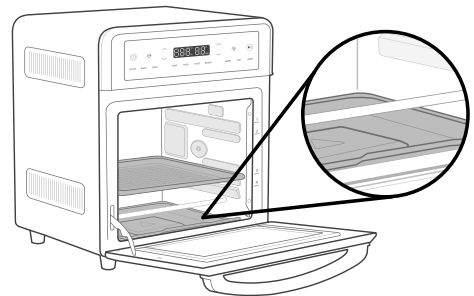

Figure 1.1

Tray Positions

Each cooking function has a recommended tray position with slots that you can slide a tray into (the food tray or air fryer tray). The standard recommended positions are indicated on the front of the air fryer [Figure 1.2]. The four positions are numbered 1, 2, 3, and 4, from top to bottom.

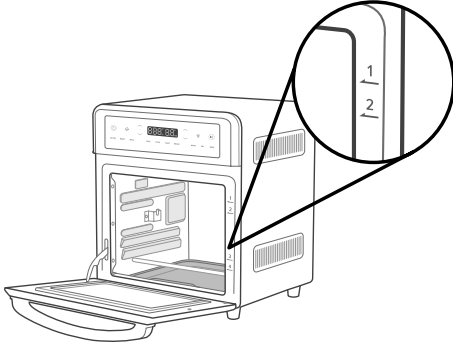

Figure 1.2

Cooking Greasy Foods

When cooking with oil or air frying greasy food such as beef, chicken, or pork, place the air fryer tray on the food tray (or insert the food tray underneath the air fryer tray) to prevent oil from dripping on the heating elements. [Figure 1.3]

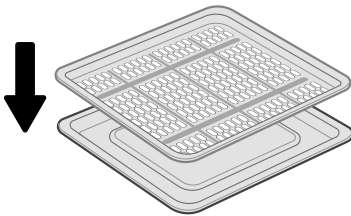

Figure 1.3

Rotisserie Handle

The rotisserie handle is used to place the rotisserie basket or fork set into the rotisserie slots in the air fryer oven. [Figure 1.4] The handle is also used to remove the rotisserie basket and fork set after cooking is finished.

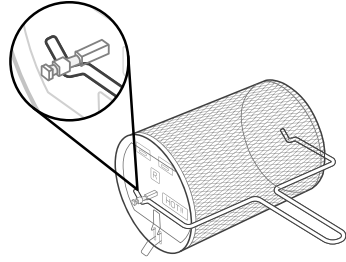

Figure 1.4

Rotisserie Basket

The rotisserie basket is used for air frying small foods, such as french fries, nuggets, or Brussels sprouts.

1. Press the wire latch to open the door on the side of the rotisserie basket. [Figure 1.5]
2. Place food inside the basket and close the door.
3. Use the rotisserie handle to place the basket inside the air fryer oven, securing both ends of the rotisserie shaft into the rotisserie slots.

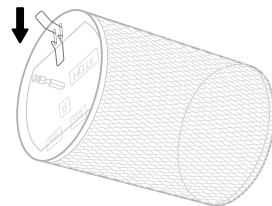

Figure 1.5

Rotisserie Fork Set

The rotisserie fork set is used for rotating roasts and is ideal for roasting a whole chicken. **Do not** cook more than 4 pounds at a time on the rotisserie fork set.

1. Slide the food item onto the rotisserie shaft.
2. Place the rotisserie forks on either side of the shaft and insert them into the food item to secure it on the shaft. Tighten the knobs on the forks to secure them. [Figure 1.6]

Note: When cooking a rotisserie chicken, secure the legs and wings with butcher's twine so they do not hang loosely as the chicken rotates.

3. Use the rotisserie handle to place the food item inside the air fryer oven, securing both ends of the rotisserie shaft into the rotisserie slots.

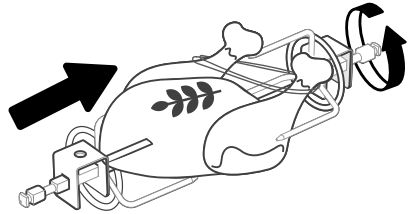









Figure 1.6

Cooking Functions

Cooking functions are programmed with an ideal time and temperature for cooking certain foods. For more information on each cooking function, see its individual section, or the **Cooking Functions Quick Reference Chart** (see page 15).

Customizing Cooking Functions

- You can customize a cooking function's default settings, including time and temperature.
- To change a function's default settings:
 1. When the air fryer is not cooking or is paused, tap the cooking function you want to change.
 2. Select the settings you want to set as default.
 - a. Tap the respective  and  buttons to adjust temperature and/or time.
 - b. For Toast, tap the  and  buttons on the right side of the display to change the toast darkness level.
- To reset one function:
 1. When the air fryer is not cooking or is paused, tap the cooking function you want to reset.
 2. Without making any changes, press and hold the right  and  buttons at the same time for 5 seconds until the air fryer beeps 1 time.
- To reset all functions:
 1. When the air fryer is not cooking or is paused, press and hold  for 10 seconds. This will reset all cooking functions.

Cooking Functions Quick Reference Chart

Name	Use	Suggested Accessory & Position	Fan Speed*	Range
AIR FRY	<ul style="list-style-type: none"> • Cooks using intense heat and maximized airflow • Cook food such as french fries and chicken wings • Includes preheat • Optional rotisserie function 	<p>Air fryer tray at level 2 or 3 position</p> <p>Rotisserie basket in rotisserie slots</p>	High	<ul style="list-style-type: none"> • 180°–450°F / 80°–230°C • 1 min–1 hr
ROAST	<ul style="list-style-type: none"> • Cook a variety of meats and poultry • Food will be tender and juicy on the inside and well-roasted on the outside. • Includes preheat • Optional rotisserie function 	<p>Food tray at level 4 position</p> <p>Rotisserie basket or fork set in rotisserie slots</p>	High	<ul style="list-style-type: none"> • 180°–450°F / 80°–230°C • 1 min–1 hr
BROIL	<ul style="list-style-type: none"> • Cook open-faced sandwiches, thin cuts of meat (such as bacon), poultry, fish, sausages, and vegetables • Brown the tops of casseroles, gratins, and desserts 	Food tray at level 1 position	High	<ul style="list-style-type: none"> • 350°–450°F / 175°–230°C • 1 min–30 min
BAKE	<ul style="list-style-type: none"> • Cook food evenly throughout • Bake cakes, muffins, and pastries • Includes preheat 	Food tray or air fryer tray at level 3 position	Low	<ul style="list-style-type: none"> • 180°–450°F / 80°–230°C • 1 min–1 hr
PIZZA	<ul style="list-style-type: none"> • Melt and brown cheese and toppings while crisping crust • Includes preheat 	Air fryer tray at level 2 position	Low	<ul style="list-style-type: none"> • 180°–450°F / 80°–230°C • 1 min–1 hr
TOAST	<ul style="list-style-type: none"> • Toast or brown bread 	Air fryer tray at level 4 position	Low	<ul style="list-style-type: none"> • Darkness Level 1–7 • 450°F / 230°C • Time is automatic
REHEAT	<ul style="list-style-type: none"> • Reheat leftovers without overcooking or drying out food 	Food tray at level 3 position	Low	<ul style="list-style-type: none"> • 120°–360°F / 60°–180°C • 1 min–1 hr

KEEP WARM ("WARM")	<ul style="list-style-type: none"> Keep food warm at the recommended temperature to prevent bacterial growth (160°F or above) 	Food tray or air fryer tray at level 4 position	Low	<ul style="list-style-type: none"> 150°–230°F / 65°–110°C 1 min–1 hr
DEHYDRATE ("DRY")	<ul style="list-style-type: none"> Evenly dry out food without cooking Dry fruit or vegetable chips 	Air fryer tray at level 2 or 3 position	Low	<ul style="list-style-type: none"> 100°–180°F / 40°–80°C 0.5 hr–12 hr
PROOF	<ul style="list-style-type: none"> Precisely hold low temperatures Proof bread, rolls, pizza, and dough Make yogurt 	Food tray or air fryer tray at level 4 position	Low	<ul style="list-style-type: none"> 90°–120°F / 30°–50°C 30 min–12 hr

*Fan speed cannot be changed and is automatically set with each cooking function.

Preheating

The following cooking functions automatically include preheat: **Air Fry**, **Roast**, **Bake**, and **Pizza**.

1. Tap a cooking function that includes preheat.
2. Tap  to start the cooking function. "PrE" will show on the display and the air fryer will begin preheating.
3. When preheating is finished, the air fryer will beep 3 times and "Add Food" will show on the display.
4. Open the air fryer door and place food inside, then close the door to start cooking.

Note: Tap  during preheating to skip the preheating stage.

Air Fry Function (“AIR FRY”)









This function is ideal for cooking a variety of food, including french fries and chicken wings. Uses intense heat and maximized airflow.

Heating Elements: Top and bottom heating elements cycle on and off. If using the rotisserie function, the bottom heating elements are turned off.

Rack Position: Level 2 or 3

Fan Speed: High

1. Tap **AIR FRY** to select the Air Fry cooking function.
2. Optionally, customize the temperature and time. You can do this anytime during cooking (except during preheating).
 - a. Tap  and  to adjust the temperature between 180°–450°F / 80°–230°C.
 - b. Tap  and  to adjust the time between 1 min–1 hr.
3. Tap  to begin preheating. The  button will light up, and the display will show “**PRE**”. When preheating is finished, the air fryer will beep 3 times and “**Add Food**” will show on the display.
 - a. Tap  during preheating to skip the preheating stage.
4. Place food in the air fryer tray or rotisserie basket.
 - a. Avoid overfilling the air fryer tray, or food may not air fry correctly.
 - b. When air frying fatty foods (such as chicken wings), place the air fryer tray on the food tray (or insert the food tray underneath the air fryer tray) to prevent oil from dripping on the heating elements.
5. Insert at level 2 or 3 position.
6. Close the air fryer door to start cooking. The display will show the timer counting down.
7. The air fryer will stop heating and beep several times when finished.

Roast Function (“ROAST”)









This function is ideal for cooking a variety of meats and poultry. Food will be tender and juicy on the inside and well-roasted on the outside.

Heating Elements: Top and bottom heating elements cycle on and off. If using the rotisserie function, the bottom heating elements are turned off.

Rack Position: Level 4

Fan Speed: High

1. Tap **ROAST** to select the Roast cooking function.
2. Optionally, customize the temperature and time. You can do this anytime during cooking (except during preheating).
 - a. Tap  and  to adjust the temperature between 180°–450°F / 80°–230°C.
 - b. Tap  and  to adjust the time between 1 min–1 hr.
3. Tap  to begin preheating. The  button will light up, and the display will show “PrE”. When preheating is finished, the air fryer will beep 3 times and “Add Food” will show on the display.
 - a. Tap  during preheating to skip the preheating stage.
4. Place food inside the air fryer. Insert the food tray at level 4 position.
 - a. Optionally, use the rotisserie handle to place the rotisserie basket or rotisserie fork set in the designated slots.

Note: Use extreme caution when using foil, and **always** fit foil as securely as possible. To avoid overheating and risk of fire, make sure foil does not contact the heating elements.
5. Close the air fryer door to start cooking. The display will show the timer counting down.
6. The air fryer will stop heating and beep several times when finished.

Broil Function (“BROIL”)







This function is ideal for cooking open-faced sandwiches, thin cuts of meat (such as bacon), poultry, fish, sausages, and vegetables.

Can also be used to brown the tops of casseroles, gratins, and desserts.

Heating Elements: Top heating elements cycle on and off.

Rack Position: Level 1

Fan Speed: High

1. Place food on the food tray.
 - a. Optionally, lightly grease the food tray or line with foil to prevent food from sticking.
 - b. Use extreme caution when using foil, and **always** fit foil as securely as possible. To avoid overheating and risk of fire, make sure foil does not contact the heating elements.
2. Insert the food tray at level 1 position.
 - a. Insert at mid position instead for:
 - Bulky food that may touch the upper heating elements
 - Thicker food such as burger patties
 - Marinated food such as chicken wings
 - Food requiring a gentler broil
3. Tap **BROIL** to select the Broil cooking function.
4. Optionally, customize the temperature and time. You can do this anytime during cooking (except during preheating).
 - a. Tap  and  to adjust the temperature between 350°–450°F / 175°–230°C.
 - b. Tap  and  to adjust the time between 1 min–30 min.
5. Tap  to begin cooking. The display will show the timer counting down.
6. The air fryer will stop heating and beep several times when finished.

Bake Function (“BAKE”)









This function cooks food evenly throughout. Ideal for baking cakes, muffins, brownies, and pastries. Also ideal for cooking pre-packaged frozen meals, including lasagna and pot pies.

Heating Elements: Top and bottom heating elements cycle on and off.

Rack Position: Level 3

Fan Speed: Low

1. If using the air fryer tray, insert at level 3 position and close the air fryer door.
2. Tap **BAKE** to select the Bake cooking function.
3. Optionally, customize the temperature and time. You can do this anytime during cooking (except during preheating).
 - a. Tap  and  to adjust the temperature between 180°–450°F / 80°–230°C.
 - b. Tap  and  to adjust the time between 1 min–1 hr.
4. Tap  to begin preheating. The  button will light up, and the display will show “PrE”. When preheating is finished, the air fryer will beep 3 times and “Add Food” will show on the display.
 - a. Tap  during preheating to skip the preheating stage.
5. Place food inside the air fryer. If using the food tray, insert at mid position.

Note: Use extreme caution when using foil, and **always** fit foil as securely as possible. To avoid overheating and risk of fire, make sure foil does not contact the heating elements.
6. Close the air fryer door to start cooking. The display will show the timer counting down.
7. The air fryer will stop heating and beep several times when finished.

Pizza Function (“PIZZA”)







This function melts and browns cheese and toppings while crisping crust.



Heating Elements: Top and bottom heating elements cycle on and off.

Rack Position: Level 2

Fan Speed: Low

1. Insert the air fryer tray at level 2 position and close the air fryer door.
2. Tap **PIZZA** to select the Pizza cooking function.
3. Optionally, customize the temperature and time. You can do this anytime during cooking (except during preheating).
 - a. Tap  and  to adjust the temperature between 180°–450°F / 80°–230°C.
 - b. Tap  and  to adjust the time between 1 min–1 hr.

Note: Try a slightly longer cook time for pizzas with thicker crust, and an even longer cook time for frozen pizzas.

4. Tap  to begin preheating. The  button will light up, and the display will show “PrE”. When preheating is finished, the air fryer will beep 3 times and “Add Food” will show on the display.
 - a. Tap  during preheating to skip the preheating stage.

5. Remove any cardboard, plastic, paper, or other flammable materials. Place pizza on a pan, and place the pan on the air fryer tray.
6. Close the air fryer door to start cooking. The display will show the timer counting down.

Note: For large pizzas, open the air fryer door halfway through cooking and carefully turn the pizza 90 degrees for more even browning.

7. The air fryer will stop heating and beep several times when finished.

Toast Function (“TOAST”)





This function browns the outside of your bread while keeping the inside soft. Also ideal for English muffins and frozen waffles.

Heating Elements: Top and bottom heating elements cycle on and off.

Rack Position: Level 4

Fan Speed: Low

1. Place up to 4 slices of bread on the air fryer tray. Insert the tray at level 4 position and close the air fryer door.
2. Tap **TOAST** to select the Toast cooking function.
3. Optionally, customize the darkness level. You can **only** do this before cooking starts.
 - a. Tap the  and  buttons on the right side of the display to change the toast darkness level from L1–L7.
 - b. Use L1–L2 for a light toast, L3–L5 for a medium toast, and L6–L7 for a dark toast.

Note:

- When setting the toast darkness level, consider the type, thickness, and freshness of the bread.
 - Try lighter settings for raisin toast, white bread, and thinly-sliced bread.
 - Try darker settings for rye, whole wheat, heavier-textured bread, and fresh bread.
 - Time and temperature are set automatically. Time increases with toast darkness level. Temperature is set to the highest level (450°F / 230°C).
4. Tap  to begin toasting. The button will light up, and the display will show the timer counting down.
 5. The air fryer will stop heating and beep several times when finished.

Reheat Function (“REHEAT”)







This function is designed to reheat leftovers without overcooking or drying out the food.

Heating Elements: Top heating elements cycle on and off.

Rack Position: Level 3

Fan Speed: Low

1. Place food on the food tray. Insert at level 3 position and close the air fryer door.
2. Tap **REHEAT** to select the Reheat cooking function.
3. Optionally, customize the temperature and time. You can do this anytime during cooking.
 - a. Tap  and  to adjust the temperature between 120°–360°F / 60°–180°C.
 - b. Tap  and  to adjust the time between 1 min–1 hr.
4. Tap  to begin reheating. The button will light up, and the display will show the timer counting down.
5. The air fryer will stop heating and beep several times when finished.

Keep Warm Function (“WARM”)







This function is designed to keep food warm at the recommended temperature to prevent bacterial growth (160°F / 70°C or above).

Heating Elements: Top heating elements cycle on and off.

Rack Position: Level 4

Fan Speed: Low

1. Place hot food in a heat-safe container. Cover and place on the food tray or air fryer tray. Insert at level 4 position and close the air fryer door.
2. Tap **WARM** to select the Warm cooking function.
3. Optionally, customize the temperature and time. You can do this anytime during cooking.
 - a. Tap  and  to adjust the temperature between 150°–230°F / 65°–110°C.
 - b. Tap  and  to adjust the time between 1 min–1 hr.
4. Tap  to begin warming. The button will light up, and the display will show the timer counting down.
5. The air fryer will stop heating and beep several times when finished.

Dehydrate Function (“DRY”)



This function combines low and stable heat with steady airflow to evenly dry out foods without cooking. Ideal for drying fruit or vegetable chips.





Heating Elements: Top heating elements cycle on and off.

Rack Position: Level 2 or 3

Fan Speed: Low

1. Place food on the air fryer tray.
 - a. When dehydrating foods that may drip, such as marinated jerky, place the food tray in the low rack position to catch drippings.
 - b. Optionally, to prevent staining when dehydrating certain foods (such as beets or marinated meats with dark sauces), line the rack or basket with baking paper.

Note: Never put baking or parchment paper into the air fryer without food on top. Air circulation can cause paper to move and touch heating elements.

2. Insert air fryer tray at level 2 or 3 position. Close the air fryer door.
3. Tap **DRY** to select the Dehydrate cooking function.
4. Optionally, customize the temperature and time. You can do this anytime during cooking.
 - a. Tap  and  to adjust the temperature between 100°–180°F / 40°–80°C.
 - b. Tap  and  to adjust the time between 30 min–12 hr.
5. Tap  to begin dehydrating. The button will light up, and the display will show the timer counting down.
6. The air fryer will stop heating and beep several times when finished.

Proof Function (“PROOF”)







This function is designed to precisely hold low temperatures, providing an ideal environment for proofing bread, rolls, pizza, and dough.

Can also be used for making yogurt with an appropriate recipe (using 110°F / 40°C temperature and 12 hr time).

Heating Elements: Bottom heating elements cycle on and off.

Rack Position: Level 4

Fan Speed: Low

1. Place dough in a heat-safe container. Cover and place on the food tray or air fryer tray. Insert at level 4 position and close the air fryer door.
2. Tap **PROOF** to select the Proof cooking function.
3. Optionally, customize the temperature and time. You can do this anytime during cooking.
 - a. Tap  and  to adjust the temperature between 90°–120°F / 30°–50°C.
 - b. Tap  and  to adjust the time between 30 min–1 hr.
4. Tap  to begin fermentation. The button will light up, and the display will show the timer counting down.
5. The air fryer will stop heating and beep several times when finished.

CARE & MAINTENANCE

Clean air fryer accessories (including trays, etc.) and air fryer interior after every use.

Note:

- **Do not** use abrasive cleaners, metal scouring pads, or metal utensils on any part of the air fryer, including trays and other accessories. These will scratch or damage their surfaces.
 - This air fryer contains no user-serviceable parts. Any repairs should be performed by an authorized service representative.
1. Before cleaning, turn off and unplug the air fryer, and allow it to cool completely. Open the door for faster cooling.
 2. Apply non-abrasive liquid cleanser or a mild spray solution to a soft, damp cloth or sponge (not the air fryer surface) and wipe all parts of the air fryer, especially the air fryer interior. **Do not** use a dry cloth on the display screen, or it may be scratched.

Note: Make sure you clean the top of the air fryer interior after every use. If this is not cleaned, cooking residue will burn onto the air fryer interior and be difficult to remove.

3. To clean the glass door, use a glass cleaner or mild detergent and a soft, damp sponge or soft, plastic scouring pad.
4. Let all surfaces dry completely before plugging in or turning on the air fryer.

Cleaning the Accessories

Note: After each use, slide out the drip tray and discard crumbs.

1. Apply non-abrasive liquid cleanser or a mild spray solution to a soft, damp sponge or soft, plastic scouring pad (not the accessory surface). Wipe accessories and soak in warm, soapy water if necessary.
2. For stubborn grease:
 - a. In a small bowl, mix 2 US tbsp / 30 mL of baking soda with 1 US tbsp / 15 mL of water to form a spreadable paste.
 - b. Use a sponge to spread the paste on the trays and scrub. Let the trays sit for 15 minutes before rinsing.
 - c. Wash trays with soap and water.
3. Dry thoroughly.
4. Replace the drip tray into the air fryer before plugging in or turning on the air fryer.

Storage

1. Clean and dry the air fryer and all accessories.
2. Insert the drip tray into the air fryer. Insert the rack at mid position. Make sure the air fryer door is closed.
3. Store the air fryer in an upright position. **Do not** store anything on top.

TROUBLESHOOTING

Problem	Possible Solution
The air fryer will not turn on.	Make sure the air fryer is plugged in.
Food is not completely cooked.	Increase cooking temperature or time.
Food is overcooked or burned.	Decrease cooking temperature or time.
	Make sure food items are not too large and are not touching the heating elements.
Food is cooked unevenly.	Preheat the air fryer manually by using the Preheat function (see page 16).
	Make sure food items are not too closely packed into a tray, rack, or other container.
White smoke or steam is coming out of the oven.	The air fryer may produce some white smoke or steam during cooking. This is normal.
	During first use, dust from the packing process may cause white smoke. This is normal for toaster air fryers and many other kitchen appliances. To eliminate any dust, see Test Run (page 12).
	Excess oil or fatty foods may produce white smoke. Make sure the inside of the air fryer is cleaned properly and isn't greasy.
Dark smoke is coming out of the air fryer.	Immediately tap  and unplug your air fryer. Food is burning. Wait for smoke to clear before opening the air fryer door.
A thermometer shows that the air fryer temperature is different from the air fryer setting.	Commonly used thermometers usually have low sensitivity and take over 10 minutes to measure the correct temperature. This will not affect cooking.
Display shows Error Code "E1".	There is an open circuit in the temperature monitor. Contact Customer Support (see page 31).
Display shows Error Code "E2".	There is a short circuit in the temperature monitor. Contact Customer Support (see page 31).
Display shows Error Code "E3".	The temperature in the air fryer oven is too high. Contact Customer Support (see page 31).
Display shows Error Code "E4".	The air fryer has been plugged into an incorrect power source, such as a 220–240V outlet. Unplug the air fryer. Only use the air fryer with 120V, 60Hz outlets, such as those in North America.

If your problem is not listed, please contact **Customer Support** (see page 31).

FEDERAL COMMUNICATION COMMISSION INTERFERENCE STATEMENT - PART 15

This device complies with Part 15 of the FCC Rules. Operation is subject to the following two conditions:

1. This device may not cause harmful interference, and
2. This device must accept any interference received, including interference that may cause undesired operation.

NOTE: This equipment has been tested and found to comply with the limits for a Class B digital device, pursuant to Part 15 of the FCC Rules. These limits are designed to provide reasonable protection against harmful interference in a residential installation. This equipment generates, uses and can radiate radio frequency energy and, if not installed and used in accordance with the instructions, may cause harmful interference to radio communications. However, there is no guarantee that interference will not occur in a particular installation. If this equipment does cause harmful interference to radio or television reception, which can be determined by turning the equipment off and on, the user is encouraged to try to correct the interference by one or more of the following measures:

- Reorient or relocate the receiving antenna.
- Increase the separation between the equipment and receiver.
- Connect the equipment into an outlet on a circuit different from that to which the receiver is connected.
- Consult the dealer or an experienced radio/TV technician for help.

FCC Caution: Any changes or modifications not expressly approved by the party responsible for compliance could void the user's authority to operate this equipment.

FCC SUPPLIER'S DECLARATION OF CONFORMITY (SDOC)

Arovast Corporation hereby declares that this equipment is in compliance with FCC requirements. The declaration of conformity may be consulted in the support section of our website, accessible from www.cosori.com

WARRANTY INFORMATION

Product	13-Quart Air Fryer Oven
Models	CAF-R121-SUS
For your own reference, we strongly recommend that you record your order ID and date of purchase.	
Order ID	
Date of Purchase	

TERMS & POLICY

Arovast Corporation (“Arovast”) warrants this product to the original purchaser to be free from defects in material and workmanship, under normal use and conditions, for a period of 2 years from the date of original purchase.

Arovast agrees, at our option during the warranty period, to repair any defect in material or workmanship or furnish an equal product in exchange without charge, subject to verification of the defect or malfunction and proof of the date of purchase.

There is no other express warranty. This warranty does not apply:

- If the product has been modified from its original condition;
- If the product has not been used in accordance with directions and instructions in the user manual;
- To damages or defects caused by accident, abuse, misuse or improper or inadequate maintenance;
- To damages or defects caused by service or repair of the product performed by an unauthorized service provider or by anyone other than Arovast;
- To damages or defects occurring during commercial use, rental use, or any use for which the product is not intended;
- To damages or defects exceeding the cost of the product.

Arovast will not be liable for indirect, incidental, or consequential damages in connection with the use of the product covered by this warranty.

This warranty extends only to the original consumer purchaser of the product and is not transferable to any subsequent owner of the product regardless of whether the product is transferred during the specified term of the warranty.

This warranty does not extend to products purchased from unauthorized sellers. Arovast’s warranty extends only to products purchased from authorized sellers that are subject to Arovast’s quality controls and have agreed to follow its quality controls.

All implied warranties are limited to the period of this limited warranty.

This warranty gives you specific legal rights and you may also have other rights which vary from state to state. Some states do not allow the exclusion or limitation of incidental or consequential damages, so the above limitation or exclusion may not apply to you.

If you discover that your product is defective within the specified warranty period, please contact Customer Support via **support@cosori.com**. **DO NOT** dispose of your product before contacting us. Once our Customer Support Team has approved your request, please return the product with a copy of the invoice and order ID.

Every COSORI product automatically includes a 2-year warranty. To make the customer support process quick and easy, register your product online at www.cosori.com/warranty.

This warranty is made by:

Arovast Corporation
1202 N. Miller St., Suite A
Anaheim, CA 92806

CUSTOMER SUPPORT

If you have any questions or concerns about your new product, please contact our helpful Customer Support Team.

Arovast Corporation
1202 N. Miller St., Suite A
Anaheim, CA 92806

Support Hours

Mon–Fri, 9:00 am–5:00 pm PST/PDT

Email: support@cosori.com

Toll-Free: (888) 402-1684

** Please have your invoice and order ID ready before contacting Customer Support.*

SHOW US WHAT YOU'RE MAKING

We hope this has been helpful to you. We can't wait to see your beautiful results, and we think you'll want to share glam shots! Our community awaits your uploads—just pick your platform of choice below. Snap, tag, and hashtag away, COSORI chef!

#LiveLifeTastefully #iCookCOSORI

@COSORICooks

@COSORI



COSORI®

Questions or Concerns?

Mon–Fri, 9:00 am–5:00 pm PST/PDT
support@cosori.com | (888) 402-1684