

COSORI®

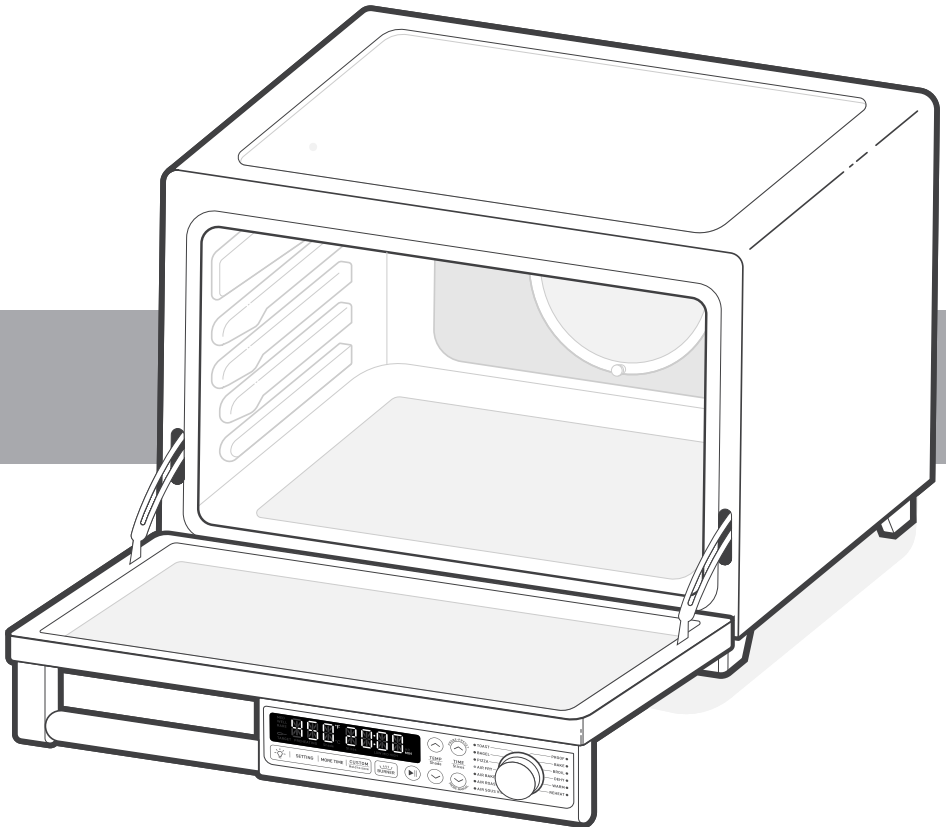

User Manual

13-in-1 26-Quart Ceramic Air Fryer Oven



Questions or Concerns?

support@cosori.com | (888) 402-1684
Mon-Fri, 9:00 am-5:00 pm PST/PDT

 Thank you for
your purchase! 

(We hope you love your new air fryer oven as much as we do)



Get Creative with COSORI

Download the free VeSync app to access original recipes and video tutorials from the COSORI chefs, interact with our online community, and more!



explore

our digital recipe gallery
cosori.com



enjoy

weekly, featured recipes
made exclusively by our in-house chefs



CONTACT OUR CHEFS

Our helpful, in-house chefs are ready to assist you with any questions you might have!

Email: recipes@cosori.com

Toll-Free: (888) 402-1684

Mon–Fri, 9:00 am–5:00 pm PST/PDT

On behalf of all of us at COSORI,

Happy cooking!

Table of Contents

Package Contents	3
Specifications	3
Important Safeguards	4
Getting To Know Your Air Fryer Oven	6
Before First Use	10
Cooking Functions	15
Care & Maintenance	24
Troubleshooting	26
Warranty Information	29
Customer Support	31

Package Contents

1 x 26-Quart Ceramic Air Fryer Oven
1 x Splatter Guard
1 x Thermometer
1 x Casserole Pan
1 x Wire Rack
1 x Sheet Tray
1 x Roasting Rack Insert
1 x Fry Basket
1 x User Manual
1 x Recipe Book + QSG

Specifications

Model	CCO-R251-SUS
Power Supply	AC 120V, 60Hz
Rated Power	1,800W
Capacity	Approx. 26.4 qt / 25 L, 9 Slices of Toast, 12" Pizza, 5-lb Chicken
Temperature Range	80°–450°F / 25°–230°C
Time Range	1 min–24 hr
Dimensions	16.9 x 12.4 x 17.7 in / 43.1 x 31.4 x 44.9 cm
Weight	28.6 lb / 13 kg

READ AND SAVE THESE INSTRUCTIONS

IMPORTANT SAFEGUARDS

Follow basic safety precautions when using your oven. Read all instructions.

Key Safety Points

- **Do not** touch hot surfaces. Use handle.
- The outside of the oven, including the door, is hot during and after use.
- The top and bottom heating elements (inside the oven) are hot during and after use.
- **Always** use heat-resistant gloves, pads, or oven mitts when handling hot materials, and when placing items in or removing items from the oven, including trays, racks, accessories, or containers.
- Steam may release from the sides of the door during cooking. This is normal. The door is vented to release steam created from cooking high moisture food, such as frozen bread.
- Water or condensation may build up and drip from under the door if you are cooking high moisture food. This is normal.
- **Do not** block any ventilation openings. Hot steam is released through openings. Keep your hands and face clear of openings.

General Safety

- When the oven is not in use, and before cleaning, unplug it from the outlet. Allow to cool completely before putting on or taking off parts.
- To protect against electric shock, **do not immerse the oven**, cord, or plug in water or liquid.
- Close supervision is necessary when the oven is used by or near children.
- Children should be supervised to ensure that they **do not** play with the oven.
- **Do not** use your oven if it is damaged, not working, or if the cord or plug is damaged.

Contact **Customer Support** (see page 31).

- **Do not** use third-party replacement parts or accessories, as this may cause injuries.
- **Do not** use outdoors.
- **Do not** place the oven or any of its parts on a stove, near gas or electric burners, or inside a heated oven.
- Be extremely cautious when removing a tray, basket, or rack if it contains hot oil, grease, or other hot liquids.
- **Do not** clean with metal scouring pads. Metal fragments can break off the pad and touch electrical parts, creating a risk of electric shock.
- **Do not** store anything on top of your oven while it is operating. **Do not** store anything inside your oven other than recommended accessories.
- The oven is not intended to be operated by means of an external timer or separate remote-control system.
- **Only** use as directed in this manual. **Do not** use oven for any purpose other than its intended use.
- This oven is not intended for use by persons (including children) with reduced physical, sensory, or mental capabilities, or lack of experience and knowledge, unless they have been given supervision or instruction concerning use of the oven by a person responsible for their safety.
- **Do not** allow children to clean or perform maintenance on the oven.
- Keep the oven and its cord out of reach of children.
- Not for commercial use. Household use **only**.



Note: See **Care & Maintenance** for instructions on how to clean accessories (page 24).

While Cooking

- To avoid risk of fire or electric shock, **do not** place oversized foods or metal utensils into the oven.
- **Do not** place paper, cardboard, or non-heat-resistant plastic into your oven, or any materials which may catch fire or melt.
- To avoid overheating, **do not** use metal foil in the oven unless directed. Use extreme caution when using foil, and **always** fit foil as securely as possible. If the foil contacts the oven's heating elements, this can cause overheating and risk of fire.
- **Never** put baking or parchment paper into the oven without food on top. Air circulation can cause paper to move and touch heating elements.
- **Always** use heat-safe containers. Be extremely cautious if using containers that aren't metal or glass.
- Keep your oven away from flammable materials (curtains, tablecloths, walls, etc.). Use on a flat, stable, heat-resistant surface away from heat sources or liquids.
- Immediately cancel cooking and unplug your oven if you see dark smoke coming out. Food is burning. Wait for smoke to clear before opening the oven door.
- When unplugging the oven, be cautious of hot surfaces.

Power & Cord

- This oven uses a short power-supply cord to reduce the risk of entangling or tripping.
- **CAUTION:** To ensure continued protection against risk of electric shock, connect to properly grounded outlets **only**.
- Your oven has a 3-prong grounding plug, and should **only** be used with **120V, 60Hz** electrical systems in North America. **Always** plug into a grounded electrical outlet. **Do not** modify the plug in any way.
- **Do not** let the power cord (or any extension cord) hang over the edge of a table or counter, or touch hot surfaces.
- The cord should be arranged so that it will not drape over the countertop or tabletop where it can be pulled on by children or tripped over unintentionally.

- **To turn the oven off**, press and hold . All the buttons will shut off except . Press and hold  to turn the oven back on.
- If the power supply cord is damaged, it must be replaced by Arovast Corporation or similarly qualified persons in order to avoid an electric or fire hazard. Please contact **Customer Support** (page 31).

Extension Cords

- Longer extension cords are available and may be used if care is exercised in their use.
- If a longer extension cord is used:
 - The marked electrical rating of the cord set or extension cord should be at least as great as the electrical rating of the oven.
 - The cord should be arranged so that it will not drape over the countertop or tabletop where it can be pulled on by children or tripped over unintentionally.
 - The extension cord should be a grounding-type 3-wire cord.

Electromagnetic Fields (EMF)

This oven complies with all standards regarding electromagnetic fields (EMF). If handled properly and according to the instructions in this user manual, the appliance is safe to use based on scientific evidence available today.

SAVE THESE INSTRUCTIONS



CAUTION: Hot Surface.

GETTING TO KNOW YOUR AIR FRYER OVEN

Air Fryer Oven Diagram

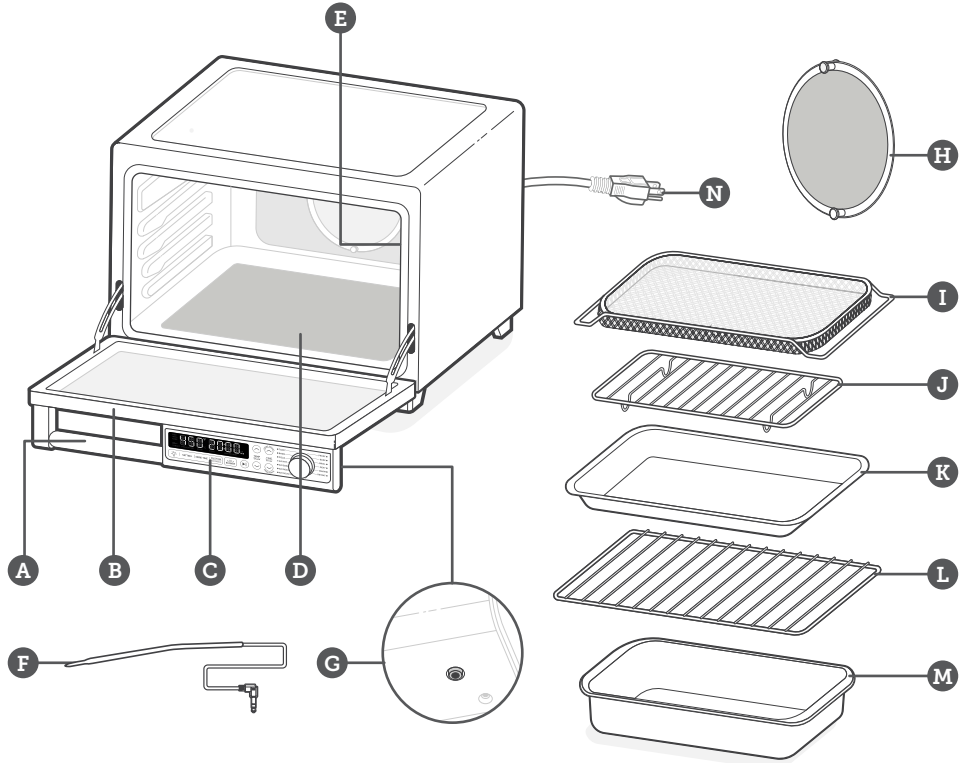

- A. Handle
- B. Door
- C. Control Panel
- D. Ceramic Burner
- E. Oven Light (Inside Oven)
- F. Thermometer
- G. Thermometer Input

- H. Splatter Guard
- I. Fry Basket
- J. Roasting Rack Insert
- K. Sheet Tray
- L. Wire Rack
- M. Casserole Pan
- N. Power Cord

Control Panel

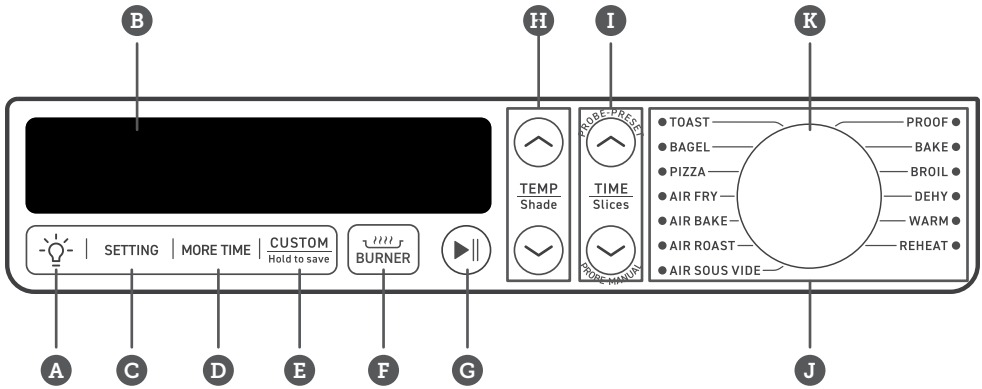

- | | |
|----------------------------|---|
| A. Light Button | G. Start/Pause Button |
| B. LED Display | H. Increase/Decrease Temperature |
| C. Setting Button | I. Increase/Decrease Time |
| D. More Time Button | J. Cooking Functions |
| E. Custom Button | K. Control Knob |
| F. Burner Button | |

Display Diagram

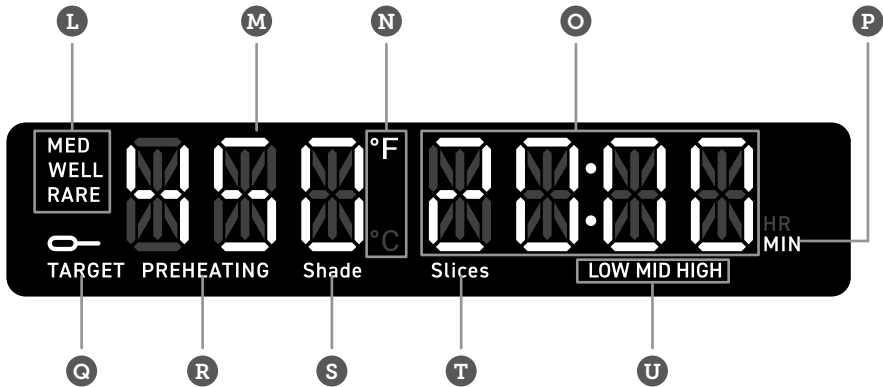

- | | |
|---|-----------------------------------|
| L. Doneness Indicators | Q. Thermometer Indicator |
| M. Temperature Display | R. Preheating Indicator |
| N. Fahrenheit/Celsius Indicators | S. Shade Indicator |
| O. Time Display | T. Slices Indicator |
| P. Hour/Minute Indicators | U. Burner Level Indicators |

CONTROLS









Start/Pause Button

- Tap to start/pause a cooking function.
- Tap during preheating to skip the preheating stage. Preheating is automatically included in the Air Fry, Air Bake, Air Roast, Bake, and Pizza cooking functions.

Control Knob







- Turn the control knob to select a cooking function.
- While the oven is paused, turn the control knob to a different function to cancel cooking.
- If there is **no operation for 45 seconds**, the oven will enter standby mode and the display will turn off.
- Turn the control knob or tap any button (except ▶||) to turn on the display and resume operation. .

Increase/Decrease Temperature

- Tap  or  to adjust the temperature setting.
- Press and hold  or  to rapidly increase or decrease the temperature.
- When using the Toast or Bagel cooking functions, tap  or  to adjust the desired shade level from 1 (light) to 7 (dark).
- When using the Burner function, tap  or  to adjust the heat level from L1 (low) to L10 (high).

Increase/Decrease Time

- Tap  or  to adjust the time setting.

- Press and hold  or  to rapidly increase or decrease the time.
- When using the Toast or Bagel cooking functions, tap  or  to adjust the number of slices from 1 to 9.
- When using the thermometer, tap  to use recommended temperature presets for the food you are cooking.
- When using the thermometer, tap  to manually input temperature settings.

Burner Button

- Tap to turn the Burner function on (see **Burner Function**, page 22).
- Cycles through LOW (L3), MID (L6), HIGH (L10), and burner off.

Custom Button

- Press and hold to save your own customized cooking function (see **Saving Custom Settings**, page 23).
- Tap to use your customized cooking function.
- **Only** one customized cooking function can be saved at a time.

More Time Button

- Tap during a cooking function to add more cooking time.
- Time increases at increments of 30 seconds, 1 minute, 5 minutes, 10 minutes, or 30 minutes depending on the cooking function.

Setting Button

- Tap to adjust oven settings (see **Oven Settings**, page 23).

Light Button

- Tap to turn the oven light on/off.
- If not manually turned off, the light will turn off automatically after 45 seconds.
- The light turns on when the door is open and during the last 10 seconds of a cooking function.
- **Press and hold to turn the oven off.** All the buttons will shut off except .
- Press and hold to turn the oven back on.

Note: When you open the door during cooking, the oven will pause cooking automatically (except when **only** using the burner function), and the oven light will turn on. When you close the door, cooking will resume and the oven light will stay on for 60 seconds, then turn off.

BEFORE FIRST USE

Setting Up

1. Remove all packaging around and inside the oven.
2. Place on a stable, level, heat-resistant surface, away from anything that can be damaged by heat.
3. Wash all accessories and wipe down the inside of the oven (see page 24).
4. Place the splatter guard in the slots inside the oven. Make sure the knobs are fully inserted and slide down until the splatter guard locks in place. **[Figure 1.1]**

Figure 1.1

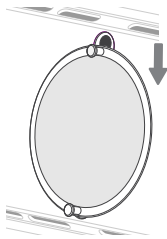

5. When the accessories are completely dry, place them back in the oven.

Test Run

A test run will help you become familiar with your oven, make sure it's working correctly, and clean it of possible residues.

1. Make sure there is no food or packaging in the oven and plug it in.
2. Turn the control knob to **AIR FRY**, then tap ►|| to begin preheating.
3. Tap ►|| again to skip the preheating stage and the display will show the timer counting down.
4. The oven will stop heating and beep when finished.

COOKING WITH YOUR AIR FRYER OVEN

CAUTION:

- The outer surface of the oven, including the oven door, is hot during and after use. **Do not** touch hot surfaces. Use handle.
- The top and bottom heating elements (inside the oven) are hot during and after use.
- **Always** use heat-resistant gloves, pads, or oven mitts when handling hot materials, and when placing items in or removing items from the oven.

Using the Accessories

Several accessories are included with your oven: the casserole pan, wire rack, sheet tray, fry basket, and roasting rack insert. The cooking functions require different accessories, so make sure to use the correct accessory for what you are cooking. Follow the recipe instructions or the suggestions given in each function section.

Note: *Certain accessories should be used together. Place the roasting rack insert on the sheet tray or casserole pan, then place on the wire rack.*

[**Figure 2.1**]

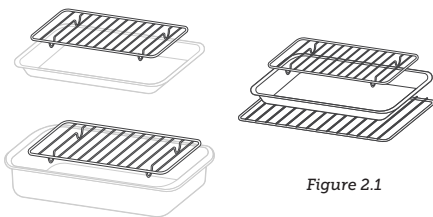

Figure 2.1

Rack Positions

Each cooking function has a recommended slot position that you can slide a tray or accessory into. The positions are indicated at the front of the oven. The positions are numbered 1, 2, 3, 4, and 5 (from top to bottom), with position 5 being directly on the ceramic burner. [**Figure 2.2**]

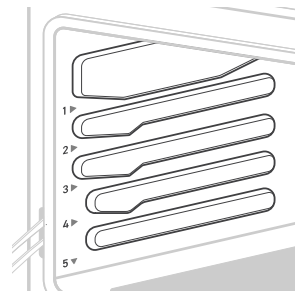

Figure 2.2

The Burner function can be used in combination with Broil, Air Fry, and Air Roast for 2-layer cooking (see **Burner Function**, page 22).

Recommended Accessory Positions - 1 Layer

Rack Position	Toast	Bagel	Pizza	Air Fry	Air Bake	Air Roast	Air Sous Vide
1	-	-	-	-	-	-	-
2	Wire Rack	Wire Rack	-	-	-	-	-
3	-	-	-	Fry Basket	Sheet Tray on Wire Rack	-	Wire Rack
4	-	-	Wire Rack	-	-	Roasting Rack Insert*	-
5	-	-	-	-	-	-	-

Rack Position	Proof	Bake	Broil	Dehydrate	Burner
1	-	-	Sheet Tray on Wire Rack	-	-
2	-	-	-	-	-
3	-	-	-	Fry Basket	-
4	Wire Rack	Sheet Tray on Wire Rack	-	-	-
5	-	-	-	-	Casserole Pan

Recommended Accessory Positions - 2 Layers

Rack Position	Dehydrate	Burner & Broil	Burner & Air Fry	Burner & Air Roast
1	-	Wire Rack	-	-
2	Fry Basket	-	-	-
3	-	-	Fry Basket	Roasting Rack Insert*
4	Wire Rack	-	-	-
5	-	Casserole Pan	Casserole Pan	Casserole Pan

*See **Figure 2.1**, page 11.

Using the Thermometer

Use the thermometer to precisely measure the internal temperature of meat, poultry, and more.

Note:

- **Do not** use the thermometer with frozen meat or cuts of meat less than 1-inch thick.
- The thermometer temperature range is 100°–200°F.

1. Insert the thermometer probe straight into the center of the **thickest** part of the meat. **[Figure 3.1]**

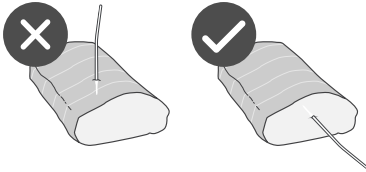

Figure 3.1

- a. For poultry, insert the probe horizontally into the inner thigh or breast. **[Figure 3.2]**

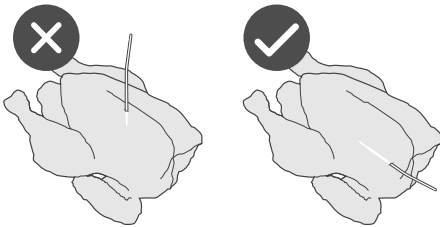

Figure 3.2

- b. Keep the probe away from fat or bones.
- c. Make sure the probe **does not** puncture all the way through the meat.

2. Place the food into the oven. Plug the thermometer into the thermometer input. **[Figure 3.3]**

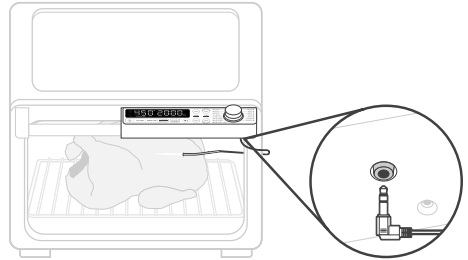





Figure 3.3





3. Turn the control knob to your desired cooking function.
 - a. The thermometer can **only** be used with the Air Fry, Air Bake, Air Roast, Bake, Dehydrate, Reheat, and Burner cooking functions.
4. Select the target internal temperature. You can cycle through presets or manually input temperature.

USING PRESETS:

- Tap **TIME**  to select a preset.
- Turn the control knob to select the type of meat: Steak, Pork, Chicken, or Fish.
- Tap **TEMP**  or  to adjust the desired doneness, according to the following chart:

	Rare	Med Rare	Med	Med Well	Well
Steak	120°–130°F	135°–140°F	145°–150°F	155°–160°F	165°–170°F
Pork	-	-	145°–150°F	155°–160°F	165°–170°F
Chicken	-	-	-	-	165°–170°F
Fish	-	120°–130°F	135°–140°F	145°–150°F	155°–160°F

MANUAL INPUT:

- Tap **TIME**  to manually input temperature.
 - Tap **TEMP**  or  to adjust the target internal temperature from 100°–200°F.
- Tap  to begin cooking. The display will show the current temperature and target temperature.
 - The oven will stop heating and beep when finished. Unplug the thermometer and the oven will return to normal operation.

Standby Mode

- If there is no operation for 45 seconds, the oven will enter standby mode and the display will turn off.
- Turn the control knob or tap any button to turn on the display and resume operation.

Door Sensor

When you open the door during cooking, the oven will pause cooking automatically and the oven light will turn on. When you close the door, cooking will resume and the oven light will stay on for 60 seconds, then turn off.

When **only** the Burner function is being used, the oven **will not pause** cooking when the door is open. You can cook with the ceramic burner while the door is open.

Note: If you combine the burner with another cooking function for 2-layer cooking, the oven **will pause** when you open the door.

COOKING FUNCTIONS

Cooking functions are programmed with an ideal time and temperature for cooking certain foods. For more information on each cooking function, see its individual section.



The following chart shows the default settings and additional details about each cooking function:

Cooking Functions Quick Reference Chart

Cooking Function	Temp/ Shade	Time/ Slices	Preheat Included?	Thermometer Cooking?
Toast	4	4		
Bagel	4	4		
Pizza	400°F	14 min	✓	
Air Fry	450°F	20 min	✓	✓
Air Bake	350°F	30 min	✓	✓
Air Roast	425°F	45 min	✓	✓
Air Sous Vide	135°F	2 hr		
Proof	85°F	1 hr		
Bake	350°F	30 min	✓	✓
Broil	High	10 min		
Dehydrate	135°F	6 hr		✓
Warm	160°F	1 hr		
Reheat	300°F	20 min		✓
Burner	LOW (L3)	30 min		✓

Note: The oven will remember your previously completed cooking function and its settings.

To reset all functions back to default settings:

1. Unplug the oven.
2. Plug in the oven and immediately press and hold **TIME**  and **TIME**  at the same time. This will reset all cooking functions.

Preheating

The following cooking functions automatically include preheat: Pizza, Air Fry, Air Bake, Air Roast, and Bake.

1. Turn the control knob to a cooking function that includes preheat.
2. Tap ► to begin preheating. **PREHEATING** will blink on the display.
3. When preheating is finished, the oven will beep.
4. Open the oven door and place food inside, then close the door to start cooking.

Note: Tap ► during preheating to skip the preheating stage.

Toast Function (“TOAST”)



This function browns the outside of your bread while keeping the inside soft. Also ideal for English muffins and frozen waffles.

RACK POSITION: LEVEL 2

1. Place up to 9 slices of bread on the wire rack. Insert the rack at level 2 position and close the oven door.
2. Turn the control knob to **TOAST** to select the Toast cooking function.
3. Optionally, customize the shade level and number of slices. You can **only** do this before cooking starts.
 - a. Tap **TEMP** ^ and v to adjust the toast shade level from L1–L7.
 - b. Tap **TIME** ^ and v to adjust the number of slices from 1–9.

Note:

- When setting the toast darkness level, consider the type, thickness, and freshness of the bread.

- Try lighter settings for raisin toast, white bread, and thinly sliced bread.
- Try darker settings for rye, whole wheat, heavier-textured bread, and fresh bread.

- Time and temperature are set automatically. Time increases with toast shade level and number of slices.

4. Tap ► to begin toasting. The display will show the timer counting down.
 - a. If needed, tap **MORE TIME** to add more cooking time.
5. The oven will stop heating and beep when finished.

Bagel Function (“BAGEL”)



This function browns the outside of your bagel while keeping the inside soft. Also ideal for toasting crumpets or thickly sliced specialty bread which requires one side to be more toasted than the other.

RACK POSITION: LEVEL 2

1. Place sliced bagel halves on the wire rack. Insert the rack at level 2 position and close the oven door.
 - a. We recommend toasting the bagel halves with the cut-side facing up.
2. Turn the control knob to **BAGEL** to select the Bagel cooking function.
3. Optionally, customize the shade level and number of slices. You can **only** do this before cooking starts.
 - a. Tap **TEMP** ^ and v to adjust the bagel shade level from L1–L7.
 - b. Tap **TIME** ^ and v to adjust the number of slices from 1–9.

Note: Time and temperature are set automatically. Time increases with bagel shade level and number of slices.

4. Tap **▶▶** to begin toasting. The display will show the timer counting down.
 - a. If needed, tap **MORE TIME** to add more cooking time.
5. The oven will stop heating and beep when finished.

Pizza Function (“PIZZA”)



This function melts and browns cheese and toppings while crisping crust.

RACK POSITION: LEVEL 4

1. Insert the wire rack at level 4 position and close the oven door.
2. Turn the control knob to **PIZZA** to select the Pizza cooking function.
3. Optionally, customize the temperature and time. You can do this anytime during cooking (except during preheating).
 - a. Tap **TEMP** \wedge and \vee to adjust the temperature between 130°–450°F.
 - b. Tap **TIME** \wedge and \vee to adjust the time between 1–60 min.

Note: Try a slightly longer cook time for pizzas with thicker crust and an even longer cook time for frozen pizzas.

4. Tap **▶▶** to begin preheating. **PREHEATING** will blink on the display.
 - a. Tap **▶▶** during preheating to skip the preheating stage.

5. When preheating is finished, the oven will beep.
6. Remove any cardboard, plastic, paper, or other flammable materials. Open the oven door and place the pizza on the wire rack.
7. Close the oven door to start cooking. The display will show the timer counting down.
 - a. If needed, tap **MORE TIME** to add more cooking time.

Note: For large pizzas, open the oven door halfway through cooking and carefully turn the pizza 90 degrees for more even browning.

8. The oven will stop heating and beep when finished.

Air Fry Function (“AIR FRY”)

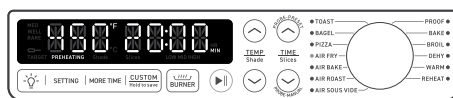

This function is ideal for cooking a variety of food, including french fries and chicken wings. Uses intense heat and maximized airflow.

RACK POSITION: LEVEL 3

1. Insert the fry basket at level 3 position and close the oven door.
2. Turn the control knob to **AIR FRY** to select the Air Fry cooking function.
3. Optionally, customize the temperature and time. You can do this anytime during cooking (except during preheating).
 - a. Tap **TEMP** \wedge and \vee to adjust the temperature between 300°–450°F.
 - b. Tap **TIME** \wedge and \vee to adjust the time between 1–60 min.
4. Tap **▶▶** to begin preheating. **PREHEATING** will blink on the display.

- a. Tap ► during preheating to skip the preheating stage.
5. When preheating is finished, the oven will beep.
6. Open the oven door and place food in the fry basket.
 - a. Avoid overfilling the basket, or food may not air fry correctly.
7. Close the oven door to start cooking. The display will show the timer counting down.
 - a. If needed, tap **MORE TIME** to add more cooking time.
8. The oven will stop heating and beep when finished.

4. Tap ► to begin preheating. **PREHEATING** will blink on the display.
 - a. Tap ► during preheating to skip the preheating stage.
5. When preheating is finished, the oven will beep.
6. Place food on the sheet tray. Open the oven door and place the sheet tray on the wire rack.
7. Close the oven door to start cooking. The display will show the timer counting down.
 - a. If needed, tap **MORE TIME** to add more cooking time.
8. The oven will stop heating and beep when finished.

Air Bake Function ("AIR BAKE")



This function is similar to the Bake function, but with increased airflow to evenly cook baked goods. Ideal for cakes, cornbread, pies, tarts, and bread.

RACK POSITION: LEVEL 3

1. Insert the wire rack at level 3 position and close the oven door.
2. Turn the control knob to **AIR BAKE** to select the Air Bake cooking function.
3. Optionally, customize the temperature and time. You can do this anytime during cooking (except during preheating).
 - a. Tap **TEMP** ^ and v to adjust the temperature between 120°–450°F.
 - b. Tap **TIME** ^ and v to adjust the time between 1 min–4 hr.

Air Roast Function ("AIR ROAST")



This function is ideal for cooking a variety of meats and poultry. Food will be tender and juicy on the inside and well-roasted on the outside.

RACK POSITION: LEVEL 4

1. Insert the wire rack at level 4 position and close the oven door.
2. Turn the control knob to **AIR ROAST** to select the Air Roast cooking function.
3. Optionally, customize the temperature and time. You can do this anytime during cooking (except during preheating).
 - a. Tap **TEMP** ^ and v to adjust the temperature between 120°–450°F.
 - b. Tap **TIME** ^ and v to adjust the time between 1 min–24 hr.

4. Tap **▶** to begin preheating. **PREHEATING** will blink on the display.
 - a. Tap **▶** during preheating to skip the preheating stage.
5. When preheating is finished, the oven will beep.
6. Place the roasting rack insert on the sheet tray, then place food on the roasting rack insert. Open the oven door and place the sheet tray on the wire rack.
7. Close the oven door to start cooking. The display will show the timer counting down.
 - a. If needed, tap **MORE TIME** to add more cooking time.
8. The oven will stop heating and beep when finished.
 - a. Tap **TEMP** \wedge and \vee to adjust the temperature between 120°–180°F.
 - b. Tap **TIME** \wedge and \vee to adjust the time between 1 min–24 hr.

Proof Function (“PROOF”)



This function is designed to precisely hold low temperatures, providing an ideal environment for proofing bread, rolls, pizza, and dough.

Can also be used for making yogurt with an appropriate recipe (using 110°F / 40°C temperature and 12 hr time).

RACK POSITION: LEVEL 4

1. Place dough in a heat-safe container. Cover and place on the wire rack. Insert at level 4 position and close the oven door.
2. Turn the control knob to **PROOF** to select the Proof cooking function.
3. Optionally, customize the temperature and time. You can do this anytime during cooking.
 - a. Tap **TEMP** \wedge and \vee to adjust the temperature between 85°–100°F.
 - b. Tap **TIME** \wedge and \vee to adjust the time between 1 min–24 hr.
4. Tap **▶** to begin proofing. The display will show the timer counting down.

Air Sous Vide Function (“AIR SOUS VIDE”)



This function is for cooking food at low temperature for a long time. Food must be vacuum sealed before cooking, which allows you to perfectly control the doneness and texture of meat, seafood, poultry, and vegetables.

RACK POSITION: LEVEL 3

1. Place vacuum sealed food on the wire rack. Insert the rack at level 3 position and close the oven door.
2. Turn the control knob to **AIR SOUS VIDE** to select the Air Sous Vide cooking function.
3. Optionally, customize the temperature and time. You can do this anytime during cooking.

- a. If needed, tap **MORE TIME** to add more cooking time.
5. The oven will stop heating and beep when finished.

Bake Function (“BAKE”)



This function cooks food evenly throughout. Ideal for baking cakes, muffins, brownies, and pastries. Also ideal for cooking pre-packaged frozen meals, including lasagna and pot pies.

RACK POSITION: LEVEL 4

1. Insert the wire rack at level 4 position and close the oven door.
2. Turn the control knob to **BAKE** to select the Baking cooking function.
3. Optionally, customize the temperature and time. You can do this anytime during cooking (except during preheating).
 - a. Tap **TEMP** \wedge and \vee to adjust the temperature between 120°–450°F.
 - b. Tap **TIME** \wedge and \vee to adjust the time between 1 min–4 hr.
4. Tap **▶▶** to begin preheating. **PREHEATING** will blink on the display.
 - a. Tap **▶▶** during preheating to skip the preheating stage.
5. When preheating is finished, the oven will beep.
6. Place food on the sheet tray. Open the oven door and place the sheet tray on the wire rack.
7. Close the oven door to start cooking. The display will show the timer counting down.

- a. If needed, tap **MORE TIME** to add more cooking time.
8. The oven will stop heating and beep when finished.

Broil Function (“BROIL”)



This function is ideal for cooking open-faced sandwiches, thin cuts of meat (such as bacon), poultry, fish, sausages, and vegetables.

Can also be used to brown the tops of casseroles, gratins, and desserts.

RACK POSITION: LEVEL 1

1. Place food on the sheet tray.
 - a. Optionally, lightly grease the sheet tray or line with foil to prevent food from sticking.
 - b. Use extreme caution when using foil, and **always** fit foil as securely as possible. To avoid overheating and risk of fire, make sure foil does not contact the heating elements.
2. Place the sheet tray on the wire rack at level 1 position.
 - a. Insert at level 2 position instead for:
 - Bulky food that may touch the upper heating elements
 - Thicker food such as burger patties
 - Marinated food such as chicken wings
 - Food requiring a gentler broil
3. Turn the control knob to **BROIL** to select the Broil cooking function.
4. Optionally, customize the temperature and time. You can do this anytime during cooking.

- a. Tap **TEMP** \wedge and \vee to adjust the temperature between HIGH, MID, and LOW.
 - b. Tap **TIME** \wedge and \vee to adjust the time between 1–30 min.
5. Tap **▶** to begin cooking. The display will show the timer counting down.
 - a. If needed, tap **MORE TIME** to add more cooking time.
 6. The oven will stop heating and beep when finished.

Dehydrate Function (“DEHY”)



This function combines low and stable heat with steady airflow to evenly dry out foods without cooking. Ideal for drying fruit or vegetable chips.

RACK POSITION: LEVEL 3

1. Arrange food in the fry basket.
 - a. For best results, arrange food in a single layer without overlapping pieces.
 - b. When dehydrating foods that may drip, such as marinated jerky, place the sheet tray (on the wire rack) below the fry basket to collect drippings.
 - c. Optionally, use parchment paper to prevent staining when dehydrating certain foods (such as beets or marinated meats with dark sauces).

Note: Never put parchment paper into the oven without food on top.

2. Insert the fry basket at level 3 position. Close the oven door.
3. Turn the control knob to **DEHY** to select the Dehydrate cooking function.

4. Optionally, customize the temperature and time. You can do this anytime during cooking.
 - a. Tap **TEMP** \wedge and \vee to adjust the temperature between 85°–180°F.
 - b. Tap **TIME** \wedge and \vee to adjust the time between 1 min–24 hr.
5. Tap **▶** to begin dehydrating. The display will show the timer counting down.
 - a. If needed, tap **MORE TIME** to add more cooking time.
6. The oven will stop heating and beep when finished.

Warm Function (“WARM”)



This function is designed to keep food warm at the recommended temperature to prevent bacterial growth (160°F / 70°C).

RACK POSITION: ANY

1. Place hot food in a heat-safe container. Cover and place on the sheet tray.
2. Place the sheet tray on the wire rack at a rack position best suited for your food. Close the oven door.
3. Turn the control knob to **WARM** to select the Warm cooking function.
4. Optionally, customize the temperature and time. You can do this anytime during cooking.
 - a. Tap **TEMP** \wedge and \vee to adjust the temperature between 110°–250°F.
 - b. Tap **TIME** \wedge and \vee to adjust the time between 1 min–24 hr.

5. Tap **▶** to begin warming. The display will show the timer counting down.
 - a. If needed, tap **MORE TIME** to add more cooking time.
6. The oven will stop heating and beep when finished.

Reheat Function (“REHEAT”)



This function is designed to reheat leftovers without overcooking or drying out the food.

RACK POSITION: ANY

1. Place food on the sheet tray.
2. Place the sheet tray on the wire rack at a rack position best suited for your food. Close the oven door.
3. Turn the control knob to **REHEAT** to select the Reheat cooking function.
4. Optionally, customize the temperature and time. You can do this anytime during cooking.
 - a. Tap **TEMP** **∧** and **∨** to adjust the temperature between 160°–450°F.
 - b. Tap **TIME** **∧** and **∨** to adjust the time between 1 min–2 hr.
5. Tap **▶** to begin reheating. The display will show the timer counting down.
 - a. If needed, tap **MORE TIME** to add more cooking time.
6. The oven will stop heating and beep when finished.

Burner Function (“BURNER”)



This function uses the ceramic burner to cook anything that would usually be cooked on a stovetop. The burner can be used with the door open. This function can be used by itself or combined with other cooking functions for 2-layer cooking.



RACK POSITION: LEVEL 5

1. Place food in the casserole pan.
2. Place the casserole pan at level 5 position (directly on the ceramic burner). Close the oven door.
 - a. You can also leave the oven door open while cooking to stir the food. The oven will not pause when the door is open.
3. Tap **BURNER** to select the Burner cooking function.
4. Optionally, customize the temperature and time. You can do this anytime during cooking.
 - a. Continue tapping **BURNER** to cycle between LOW (L3), MID (L6), HIGH (L10), and burner off.
 - b. Optionally, tap **TEMP** **∧** and **∨** to adjust the heat level from L1 (low) to L10 (high).
 - c. Tap **TIME** **∧** and **∨** to adjust the time between 1 min–1 hr.
5. Tap **▶** to begin cooking. The display will show the timer counting down.
 - a. If needed, tap **MORE TIME** to add more cooking time.

CAUTION: The ceramic burner gets very hot during cooking. **Do not** touch the surface during cooking or before it cools down.

6. The burner will stop heating and the oven will beep when finished.

2-Layer Cooking

1. Place food in the casserole pan and the appropriate accessory (see **Recommended Accessory Positions – 2 Layers**, page 12). Close the oven door.
2. Tap **BURNER** to select the Burner cooking function.
3. Optionally, customize the temperature and time. You can do this anytime during cooking.
 - a. Continue tapping **BURNER** to cycle between LOW (L3), MID (L6), HIGH (L10), and burner off.
 - b. Optionally, tap **TEMP**  and  to adjust the heat level from L1 (low) to L10 (high).
4. Turn the control knob to select a cooking function. The burner can only be combined with Broil, Air Fry, or Air Roast.
 - a. If needed, tap **MORE TIME** to add more cooking time.
5. Tap  to begin cooking. The display will show the timer counting down.
6. The oven will stop heating and beep when finished.

Saving Custom Settings

Use **CUSTOM** to save your own customized cooking function, so you can easily recreate your favorite recipe.



1. Turn the control knob to your desired cooking function and customize the temperature and time.
 - a. Additionally, you can set your desired shade level and number of slices for the Toast and Bagel functions.
2. Press and hold **CUSTOM** to save your customized function.
3. Tap **CUSTOM** to select your customized cooking function, then tap  to begin cooking.

Note: *Only one customized cooking function can be saved at a time.*



Oven Settings

Use **SETTING** to adjust oven settings.



Switch Temperature Units

1. Tap **SETTING** once.
2. Tap  or  (or turn the control knob) to cycle between Fahrenheit and Celsius.
3. Tap  to confirm your selection.

Adjust Selection Sound Volume

1. Tap **SETTING** twice.
2. Tap  or  (or turn the control knob) to adjust volume from L0 (muted) to L3.
3. Tap  to confirm your selection.

Adjust Selection Sound Style

1. Tap **SETTING** three times.
2. Tap  or  (or turn the control knob) to cycle between three different styles.
3. Tap  to confirm your selection.

CARE & MAINTENANCE

Clean oven accessories (including trays, etc.) and oven interior after every use.

Note:

- **Do not** use abrasive cleaners, metal scouring pads, or metal utensils on any part of the oven, including trays and other accessories. These will scratch or damage their surfaces.
 - This oven contains no user-serviceable parts. Any repairs should be performed by an authorized service representative.
1. Before cleaning, cancel cooking and unplug the oven, then **allow it to cool completely**. Open the door for faster cooling.
 2. Apply non-abrasive liquid cleanser or a mild spray solution to a soft, damp cloth or sponge (not directly on the oven surface) and wipe all parts of the oven, especially the oven interior.

Note: *Do not* use a dry cloth on the display screen, or it may be scratched.

3. To clean the glass door, use a glass cleaner or mild detergent and a soft, damp sponge or soft, plastic scouring pad.
4. Let all surfaces dry completely before plugging in or starting the oven.

Cleaning the Burner

- Apply a ceramic cooktop cleaner to the burner surface before using and whenever the surface is dirty.
- If any food spills on the burner surface, immediately use a metal razor scraper to remove the food or burned-on residue. This is more effective if the cooktop is still warm.

[Figure 4.1]

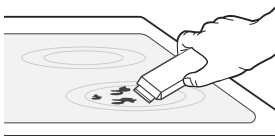

Figure 4.1

- a. **Do not** use a dull or nicked blade.
 - b. Hold the scraper at about a 30° angle to the cooktop.
 - c. If used correctly, the metal scraper will not damage the surface.
- If water spills on the burner surface, wipe it immediately with a dry paper towel.

CAUTION:

- Spills with sugar (such as preserves, ketchup, jellies, etc.) or melted plastic may cause pitting on the surface of the cooktop.
- Spills with food or water containing calcium (such as baking powder, wine, milk, spinach, etc.) may permanently stain or discolor the cooktop.

Cleaning the Accessories

- Apply non-abrasive liquid cleanser or a mild spray solution to a soft, damp sponge or soft, plastic scouring pad (not directly on the accessory surface). Wipe accessories and soak in warm, soapy water if necessary.
 - a. To extend the life of the accessories, we do not recommend placing accessories in a dishwasher.
- To clean the splatter guard, soak it in a bowl with hot water and mild detergent.
 - a. The splatter guard should be replaced when it is noticeably dirty or discolored (usually after 3 months, depending on oven usage).
- For stubborn grease:
 - a. In a small bowl, mix 2 US tbsp / 30 mL of baking soda with 1 US tbsp / 15 mL of water to form a spreadable paste.

- b. Use a sponge to spread the paste on the trays and scrub. Let the trays sit for 15 minutes before rinsing.
 - c. Wash trays with soap and water.
- Dry thoroughly.

Cleaning the Vents

- Use a vacuum cleaner with a brush or crevice attachment to clean the vents.
[Figure 4.2]
- **Do not** remove any panels from the oven.

Storage

1. Clean and dry the oven and all accessories.
2. Store the accessories in the oven. Make sure the oven door is closed.
3. Store the oven in an upright position.
Do not store anything on top.

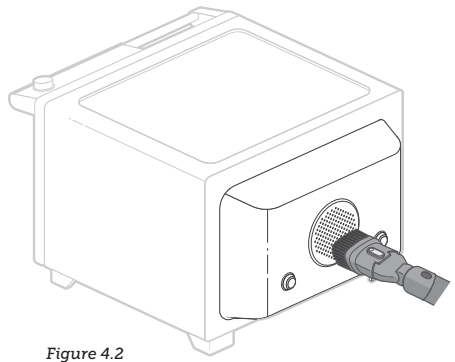

Figure 4.2

ACCESSORIES

Additional and replacement accessories are available for your air fryer oven. For more information, contact **Customer Support** (see page 31).

TROUBLESHOOTING

Problem	Possible Solution
The oven won't turn on.	Make sure the oven is plugged in.
	Try plugging the oven into a different outlet.
	Reset your circuit breaker.
The circuit breaker trips every time.	This oven requires a 15-amp circuit breaker. Make sure the oven is the only appliance plugged into an outlet on a 15-amp breaker.
Food is undercooked or overcooked even when using the thermometer.	Make sure the thermometer is inserted correctly in the thickest part of the food (see Using the Thermometer , page 13).
	Allow the food to rest for 3–5 minutes after cooking.
Food is not completely cooked.	Increase cooking temperature or time.
Food is overcooked or burned.	Decrease cooking temperature or time.
	Make sure food items are not too large and are not touching the heating elements.
Food is cooked unevenly.	Make sure food items are not too closely packed into a tray, rack, or other container.
White smoke or steam is coming out of the oven.	The oven may produce some white smoke or steam during cooking. This is normal.
	During first use, dust from the packing process may cause white smoke. This is normal for air fryer ovens and many other kitchen appliances. To eliminate any dust, see Test Run (page 10).
	Excess oil or fatty foods may produce white smoke. Make sure the inside of the oven is cleaned properly and isn't greasy.
Dark smoke is coming out of the oven.	Immediately tap ► and unplug your oven. Food is burning. Wait for smoke to clear before opening the oven door.
A thermometer shows that the oven temperature is different from the oven setting.	Commonly used thermometers usually have low sensitivity and take over 10 minutes to measure the correct temperature. This will not affect cooking.
Display shows Error Code "E1".	There is an open circuit in the temperature monitor. Contact Customer Support (see page 31).
Display shows Error Code "E2".	There is a short circuit in the temperature monitor. Contact Customer Support (see page 31).
Display shows Error Code "E3".	The temperature sensor may be broken. Contact Customer Support (see page 31).

TROUBLESHOOTING (CONT.)

Display shows Error Code "E4".	The oven has been plugged into an incorrect power source, such as a 220–240V outlet. Unplug the oven. Only use the oven with 120V, 60Hz outlets, such as those in North America.
Display shows Error Code "E4".	The oven has been stored at a temperature lower than -7°F / -22°C. Place the oven at room temperature and try again.
Display shows Error Code "E13".	There is a control signal issue. Contact Customer Support (see page 31).
Display shows Error Code "E14".	The cooling fan for the power board is broken. Contact Customer Support (see page 31).
Display shows Error Code "E15".	There is an open circuit in the temperature monitor of the burner. Contact Customer Support (see page 31).

If your problem is not listed, please contact **Customer Support** (see page 31).

FEDERAL COMMUNICATION COMMISSION INTERFERENCE STATEMENT - PART 15

This device complies with Part 15 of the FCC Rules. Operation is subject to the following two conditions:

1. This device may not cause harmful interference, and
2. This device must accept any interference received, including interference that may cause undesired operation.

NOTE: This equipment has been tested and found to comply with the limits for a Class B digital device, pursuant to Part 15 of the FCC Rules. These limits are designed to provide reasonable protection against harmful interference in a residential installation. This equipment generates, uses and can radiate radio frequency energy and, if not installed and used in accordance with the instructions, may cause harmful interference to radio communications. However, there is no guarantee that interference will not occur in a particular installation. If this equipment does cause harmful interference to radio or television reception, which can be determined by turning the equipment off and on, the user is encouraged to try to correct the interference by one or more of the following measures:

- Reorient or relocate the receiving antenna.
- Increase the separation between the equipment and receiver.
- Connect the equipment into an outlet on a circuit different from that to which the receiver is connected.
- Consult the dealer or an experienced radio/TV technician for help.

FCC Caution: Any changes or modifications not expressly approved by the party responsible for compliance could void the user's authority to operate this equipment.

FCC SUPPLIER'S DECLARATION OF CONFORMITY (SDOC)

Arovast Corporation hereby declares that this equipment is in compliance with FCC requirements.

The declaration of conformity may be consulted in the support section of our website, accessible from www.cosori.com

WARRANTY INFORMATION

Product	13-in-1 26-Quart Ceramic Air Fryer Oven
Model	CCO-R251-SUS
<i>For your own reference, we strongly recommend that you record your order ID and date of purchase.</i>	
Date of Purchase	
Order ID	

TERMS & POLICY

COSORI Limited Product Warranty

Register your products at <https://warranty.cosori.com/> warranty to stay up to date with important product information such as product updates, limited warranties, usage and maintenance recommendations, and notifications concerning safety warnings or product recalls. Registration is not required to claim your limited warranty.

Two (2) Year Limited Consumer Product Warranty

Arovast Corporation ("Arovast") warrants that the product shall be free from defects in material and workmanship for a period of **2 years from the date of original purchase** ("Limited Warranty Period"), provided the product was used in accordance with its use and care instructions (e.g. in the intended environment and under normal circumstances).

Your Limited Warranty Benefits

During the Limited Warranty Period and subject to this limited Warranty Policy, Arovast will, in its sole and exclusive discretion, either (i) refund the purchase price if the purchase was made directly from the online COSORI store, (ii) repair any defects in material or workmanship, (iii) replace the product with another product of equal or greater value, or (iv) provide store credit in the amount of the purchase price.

Who Is Covered?

This limited warranty extends only to the original consumer purchaser of the product and is not transferable to any subsequent owner of the product, regardless of whether the product transferred ownership during the specified term of the limited warranty. The original consumer purchaser must provide verification of the defect or malfunction and proof of the date of purchase to claim the Limited Warranty Benefits.

Be Aware of Unauthorized Dealers or Sellers

This limited warranty does not extend to products purchased from unauthorized dealers or sellers. Arovast's limited warranty only extends to products purchased from authorized dealers or sellers that are subject to Arovast's quality controls and have agreed to follow its quality controls. Please be aware, products purchased from an unauthorized website or dealer may be counterfeit, used, defective, or may not be designed for use in your country. You can protect yourself and your products by making sure you only purchase from Arovast or its authorized dealers.

If you have any questions about a specific seller, or if you think you may have purchased your product from an unauthorized seller, please contact our Customer Support via support@cosori.com.

What's Not Covered?

- Normal wear and tear, including parts that might wear out over time (e.g. batteries, filters, cleaning brush, essential oil pads, etc.).
- If the proof-of-purchase has been altered in any way or is made illegible.
- If the model number, serial number or production date code on the product has been altered, removed or made illegible.
- If the product has been modified from its original condition.
- If the product has not been used in accordance with directions and instructions in the user manual.
- Damages caused by connecting peripherals, additional equipment or accessories other than those recommended in the user manual.
- Damages or defects caused by accident, abuse, misuse, or improper or inadequate maintenance.
- Damages or defects caused by service or repair of the product performed by an unauthorized service provider or by anyone other than Arovast.
- Damages or defects occurring during commercial use, rental use, or any use for which the product is not intended.
- If the unit has been damaged, including but not limited to damage by animals, lightning, abnormal voltage, fire, natural disaster, transportation, dishwasher, or water (unless the user manual expressly states that the product is dishwasher-safe).
- Incidental and consequential damages.
- Damages or defects exceeding the cost of the product.

Claiming Your Limited Warranty Service in 5 Simple Steps:

1. Make sure your product is within the specified limited warranty period.
2. Make sure you have a copy of the invoice and order ID or proof-of-purchase.
3. Make sure you have your product. **DO NOT** dispose of your product before contacting us.
4. Contact our Customer Support team via support@cosori.com.
5. Once our Customer Support team has approved your request, please return the product with a copy of the invoice and order ID.

Sole and Exclusive Remedy

THE FOREGOING LIMITED WARRANTY CONSTITUTES AROVAST CORPORATION'S EXCLUSIVE LIABILITY, AND YOUR SOLE AND EXCLUSIVE REMEDY, FOR ANY BREACH OF ANY WARRANTY OR OTHER NONCONFORMITY OF THE PRODUCT COVERED BY THIS LIMITED PRODUCT WARRANTY STATEMENT. THIS LIMITED WARRANTY IS EXCLUSIVE, AND IN LIEU OF ALL OTHER WARRANTIES. NO EMPLOYEE OF AROVAST CORPORATION OR ANY OTHER PARTY IS AUTHORIZED TO MAKE ANY WARRANTY IN ADDITION TO THE LIMITED WARRANTY IN THIS LIMITED PRODUCT WARRANTY STATEMENT.

Disclaimer of Limited Warranties

TO THE FULLEST EXTENT PROVIDED BY APPLICABLE LAW, EXCEPT AS WARRANTED IN THIS LIMITED PRODUCT WARRANTY POLICY, AROVAST CORPORATION PROVIDES THE PRODUCTS YOU PURCHASE FROM AROVAST CORPORATION "AS IS" AND AROVAST CORPORATION HEREBY DISCLAIMS ALL WARRANTIES OF ANY KIND, WHETHER EXPRESS OR IMPLIED, STATUTORY, OR OTHERWISE, INCLUDING BUT NOT LIMITED TO ANY WARRANTIES OF MERCHANTABILITY, NON-INFRINGEMENT, AND FITNESS FOR PARTICULAR PURPOSE.

Limitations of Liability

TO THE FULLEST EXTENT PROVIDED BY APPLICABLE LAW, IN NO EVENT WILL AROVAST CORPORATION, ITS AFFILIATES, OR THEIR LICENSORS, SERVICE PROVIDERS, EMPLOYEES, AGENTS, OFFICERS, OR DIRECTORS BE LIABLE FOR:

(a) DAMAGES OF ANY KIND ARISING OUT OF OR IN CONNECTION WITH PRODUCTS PURCHASED FROM AROVAST CORPORATION IN EXCESS OF THE PURCHASE PRICE PAID BY THE PURCHASER FOR SUCH PRODUCTS, OR

(b) INDIRECT, SPECIAL, INCIDENTAL, CONSEQUENTIAL, OR PUNITIVE DAMAGES EVEN IF AROVAST CORPORATION OR ONE OF ITS SUPPLIERS HAS BEEN ADVISED OF THE POSSIBILITY OR LIKELIHOOD OF SUCH DAMAGES.

AND REGARDLESS OF WHETHER CAUSED BY TORT (INCLUDING NEGLIGENCE), BREACH OF CONTRACT, OR OTHERWISE. OUR LIABILITY SHALL UNDER NO CIRCUMSTANCES EXCEED THE ACTUAL AMOUNT PAID BY YOU FOR THE DEFECTIVE PRODUCT, NOR SHALL WE UNDER ANY CIRCUMSTANCES BE LIABLE FOR ANY CONSEQUENTIAL, INCIDENTAL, SPECIAL OR PUNITIVE DAMAGES OR LOSSES, WHETHER DIRECT OR INDIRECT.

EXCEPT AS COVERED BY THIS LIMITED PRODUCT WARRANTY STATEMENT, AROVAST CORPORATION SHALL NOT BE LIABLE FOR COSTS ASSOCIATED WITH THE REPLACEMENT OR REPAIR OF PRODUCTS PURCHASED FROM IT, INCLUDING, BUT NOT LIMITED TO, LABOR, INSTALLATION, OR OTHER COSTS INCURRED BY THE USER AND, IN PARTICULAR, ANY COSTS RELATING TO THE REMOVAL OR REPLACEMENT OF ANY PRODUCT.

OTHER RIGHTS YOU MAY HAVE

SOME JURISDICTIONS DO NOT ALLOW FOR: (1) EXCLUSION OF IMPLIED WARRANTIES; (2) LIMITATION ON THE DURATION OF IMPLIED WARRANTIES; AND/OR (3) EXCLUSION OR LIMITATION OF INCIDENTAL OR CONSEQUENTIAL DAMAGES; SO THE DISCLAIMERS IN THIS POLICY MAY NOT APPLY TO YOU. IN THESE JURISDICTIONS YOU HAVE ONLY THE IMPLIED WARRANTIES THAT ARE EXPRESSLY REQUIRED TO BE PROVIDED IN ACCORDANCE WITH APPLICABLE LAW. THE LIMITATIONS OF WARRANTIES, LIABILITY, AND REMEDIES APPLY TO THE MAXIMUM EXTENT PERMITTED BY LAW.

ALTHOUGH THIS LIMITED WARRANTY GIVES YOU SPECIFIC LEGAL RIGHTS, YOU MAY HAVE OTHER RIGHTS IN YOUR JURISDICTION. THIS STATEMENT OF LIMITED WARRANTY IS SUBJECT TO APPLICABLE LAWS THAT APPLY TO YOU AND THE PRODUCT. PLEASE REVIEW THE LAWS IN YOUR JURISDICTION TO UNDERSTAND YOUR RIGHTS FULLY.

CHANGES TO THIS POLICY

We may change the terms and availability of this limited warranty at our discretion, but any changes will not be retroactive.

This warranty is made by:

AROVAST CORPORATION
1202 N. Miller St., Suite A
Anaheim, CA 92806, USA

CUSTOMER SUPPORT

If you have any questions or concerns about your new product, please contact our helpful Customer Support Team.

Arovast Corporation

1202 N. Miller St., Suite A
Anaheim, CA 92806, USA

Email: support@cosori.com

Toll-Free: (888) 402-1684

Support Hours

Mon–Fri, 9:00 am–5:00 pm PST/PDT

**Please have your invoice and order ID ready before contacting Customer Support.*

COSORI®

Questions or Concerns?

Mon-Fri, 9:00 am-5:00 pm PST/PDT
support@cosori.com | (888) 402-1684