

COSORI

User Manual

Smart 5.8-Quart Air Fryer

Model: CS358-AF Series



Questions or Concerns?

Mon-Fri, 9:00 am-5:00 pm PST/PDT
support@cosori.com | (888) 402-1684



(We hope you love your new air fryer as much as we do.)



join

the Cosori Cooks Community on Facebook
[facebook.com/groups/cosoricooks](https://www.facebook.com/groups/cosoricooks)



explore

our recipe gallery
www.cosori.com/recipes



enjoy

weekly, featured recipes
made exclusively by our in-house chefs



CONTACT OUR CHEFS

Our helpful, in-house chefs are ready to assist you with any questions you might have!

Email: recipes@cosori.com

Toll-Free: (888) 402-1684

M-F, 9:00 am–5:00 pm PST/PDT

On behalf of all of us at Cosori,

Happy cooking!

Table of Contents

Package Contents	3
Specifications	3
Important Safeguards	4
• Key Safety Points	4
• General Safety	5
• While Air Frying	5
• Plug & Cord	5
Getting to Know Your Smart Air Fryer	6
Display Diagram	7
Display Messages	8
Before First Use	9
• Setting Up	9
• Test Run	9
• Basket Tips	10
• VeSync App Setup	11
Using Your Smart Air Fryer	12
• Preheating	12
• Air Frying	13
• Shaking Food	16
• Cooking Guide	17
• More Functions	18
• VeSync App Features	19
Accessories	19
Care & Maintenance	20
Troubleshooting	21
FCC Statement	23
Limited One-Year Warranty	24
Customer Support	25

Package Contents

- 1 x Smart 5.8-Quart Air Fryer
- 1 x Recipe Book
- 1 x Quick Reference Guide
- 1 x User Manual

Specifications

Power Supply	AC 120V, 60Hz
Rated Power	1700W
Capacity	5.8 qt / 5.5 L (serves 3-5 people)
Temperature Range	170°–400°F / 77°–204°C
Time Range	1–60 min
Dimensions	11.8 x 13.8 x 12.6 in / 30 x 35 x 32 cm
Weight	12.3 lb / 5.6 kg

Note: To access additional smart air fryer functions, download the free VeSync app (see page 11).

READ AND SAVE THESE INSTRUCTIONS

IMPORTANT SAFEGUARDS

Follow basic safety precautions when using your air fryer. Read all instructions.

Key Safety Points

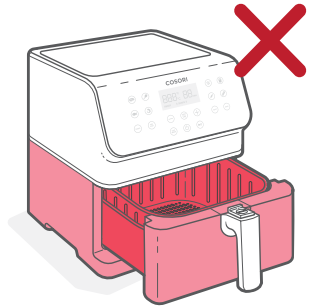

Do not touch hot surfaces. Use handle.

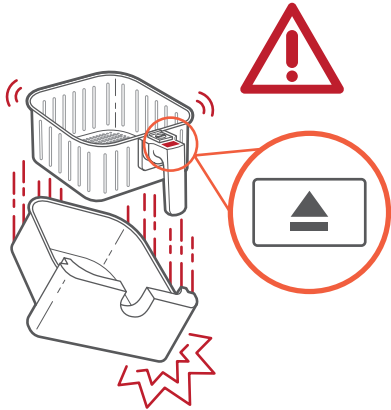

Only press the basket release button with the baskets resting flat on a counter or any level, heat-resistant surface.

The handle is attached to the inner basket, not the outer basket. When you press the basket release button, the outer basket will **drop**.

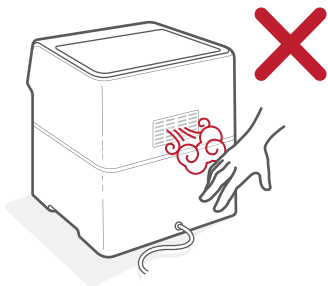

Do not block any ventilation openings. Hot steam is released through openings. Keep your hands and face clear of openings.

General Safety

- **Do not** immerse the air fryer housing or plug in water or liquid.
- Closely supervise children near your air fryer.
- Unplug when not in use, and before cleaning. Allow to cool before putting on or taking off parts.
- **Do not** use your air fryer if it is damaged, not working, or if the cord or plug is damaged. Contact **Customer Support** (see page 25).
- **Do not** use third-party replacement parts or accessories, as this may cause injuries.
- **Do not** use outdoors.
- **Do not** place the air fryer or any of its parts on a stove, near gas or electric burners, or in a heated oven.
- Be extremely cautious when moving your air fryer (or removing the baskets) if it contains hot oil or other hot liquids.
- **Do not** clean with metal scouring pads. Metal fragments can break off the pad and touch electrical parts, creating a risk of electric shock.
- **Do not** place anything on top of your air fryer. **Do not** store anything inside your air fryer.
- **Only** use your air fryer as directed in this manual.
- Not for commercial use. Household use **only**.

While Air Frying

- An air fryer works with hot air **only**. **Never** fill the baskets with oil or fat.
- **Never** use your air fryer without the baskets in place.
- **Do not** place oversized foods or metal utensils into your air fryer.
- **Do not** place paper, cardboard, non-heat-resistant plastic, or similar materials into your air fryer. You may use parchment paper or foil.
- **Never** put baking or parchment paper into the air fryer without food on top. Air circulation can cause paper to lift and touch heating coils.
- **Always** use heat-safe containers. Be extremely cautious if using containers that aren't metal or glass.
- Keep your air fryer away from flammable materials (curtains, tablecloths, etc). Use on a flat, stable, heat-resistant surface away from heat sources or liquids.

- Immediately turn off and unplug your air fryer if you see dark smoke coming out. White smoke is normal, caused by heating fat or food splashing, but dark smoke means that food is burning or there is a circuit problem. Wait for smoke to clear before pulling the baskets out. If the cause was not burnt food, contact **Customer Support** (see page 25).
- **Do not** leave your air fryer unattended while in use.

Plug & Cord

- Your air fryer has a polarized plug (one prong is wider than the other), which fits into a polarized outlet only one way. If the plug does not fit, reverse the plug. If it still does not fit, **do not** use the plug in that outlet. **Do not** alter the plug in any way.
- **Do not** let the power cord (or any extension cord) hang over the edge of a table or counter, or touch hot surfaces.
- Your air fryer should **only** be used with **120V, 60Hz** electrical systems. **Do not** plug into another type of outlet.

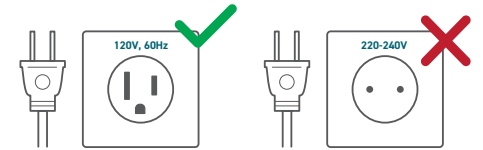

Note: This air fryer uses a short power-supply cord to reduce the risk of entangling or tripping. Use extension cords with care. The marked electrical rating of the extension cord must be as great as the rating of the fryer (see page 3).

Electromagnetic Fields (EMF)

The Cosori Smart Air Fryer complies with all standards regarding electromagnetic fields (EMF). If handled properly and according to the instructions in this user manual, the appliance is safe to use based on scientific evidence available today.

GETTING TO KNOW YOUR SMART AIR FRYER

Your Cosori Smart Air Fryer uses rapid 360° air circulation technology to cook with little-to-no oil for quick, crispy, delicious food with up to 85% fewer calories than deep fryers. With user-friendly, one-touch controls, nonstick baskets, and an intuitive, safe design, the Cosori Smart Air Fryer is the star of your kitchen.

Air Fryer Diagram



Note:

- **Do not** try to open the top of the air fryer. It is not a lid.
- The baskets are made of aluminum metal with nonstick coating. They are PFOA-free and BPA-free.

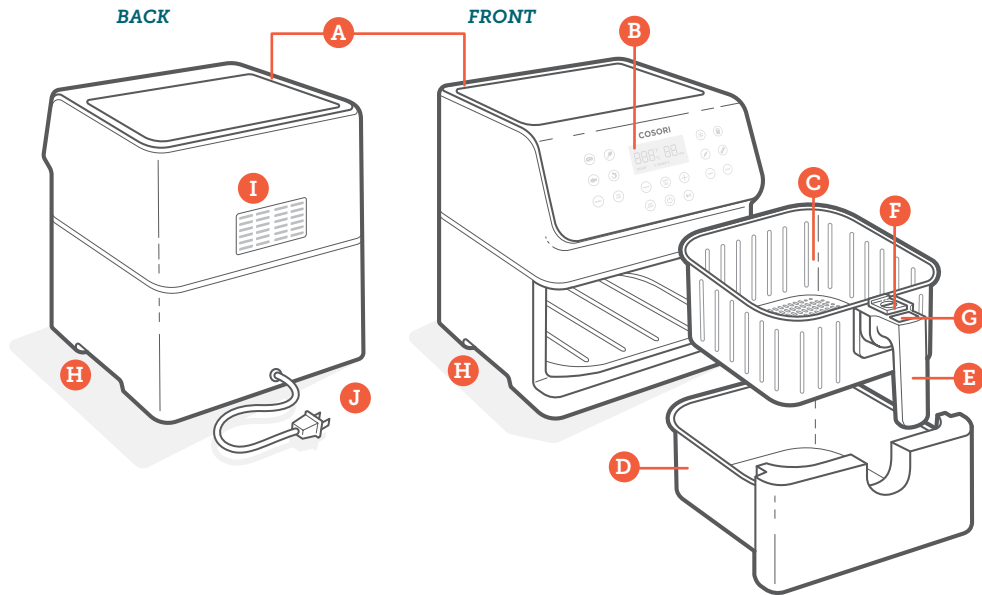

- | | | |
|-------------------|--------------------------|---------------|
| A. Air Inlet | E. Basket Handle | I. Air Outlet |
| B. Control Screen | F. Sliding Button Guard | J. Power Cord |
| C. Inner Basket | G. Basket Release Button | |
| D. Outer Basket | H. Housing Handles | |

DISPLAY DIAGRAM

Note:

- When you press a button to use a function or program, it will turn blue to show that it's active. Pressing again will deselect the function or program. [Figure 1.1]
- To save or reset presets, see **Preset Settings** (page 13).



Figure 1.1

Presets

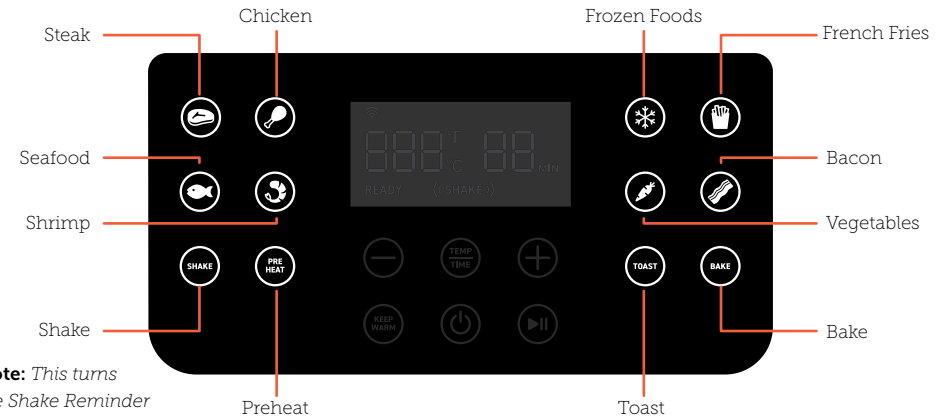

Note: This turns the Shake Reminder on/off, and is not a preset.

Control Panel

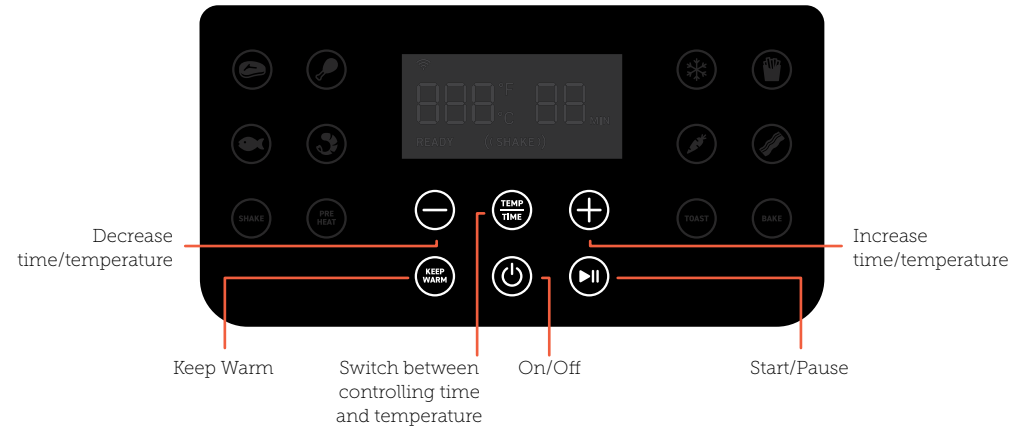

Note: Press and hold to configure your air fryer. See the VeSync in-app instructions for more information.

DISPLAY DIAGRAM (CONT.)

Display

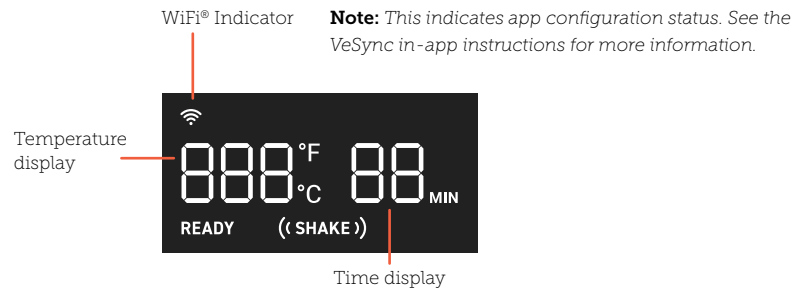

DISPLAY MESSAGES

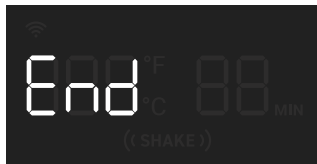

Cooking program has ended.

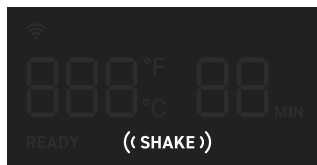

Reminder to shake or flip food.

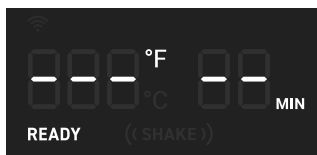

Air fryer is preheated and ready to start cooking.

BEFORE FIRST USE

Setting Up

1. Remove all packaging and temporary stickers from the air fryer.
2. Place the air fryer on a stable, level, heat-resistant surface. Keep away from areas that can be damaged by steam (such as walls or cupboards).

Note: Leave 5 in / 13 cm of space behind and above the air fryer. [Figure 2.1] Leave enough room to remove the baskets.

3. Pull the basket handle to remove the baskets. Remove all plastic from the baskets.
4. Press the basket release button to separate the inner basket from the outer basket.
5. Wash both baskets thoroughly, using either a dishwasher or a non-abrasive sponge.
6. Wipe the inside and outside of the air fryer with a slightly moist cloth. Dry with a towel.
7. Put the baskets back inside the air fryer.

Test Run

A test run will help you become familiar with your air fryer, make sure it's working correctly, and clean it of possible residues.

1. Make sure the air fryer baskets are empty, then plug in the air fryer.
2. Press **Preheat**. The display will show "400°F" and "5 MIN".
3. Press **▶▶** to begin preheating. When preheating is done, the air fryer will beep.
4. Pull out the baskets and let them cool for 5 minutes. Then place the empty baskets back in the air fryer.
5. Press **🥩** to select the **Steak** preset. The display will show "400°F" and "6 MIN".
6. Press **Temp/Time** twice. The time will blink on the display. Press the **-** button once to change the time to 5 minutes.
7. Press **▶▶** to begin. When finished, the air fryer will beep.
8. Pull out the baskets. This time, let the baskets cool completely for 10–30 minutes.

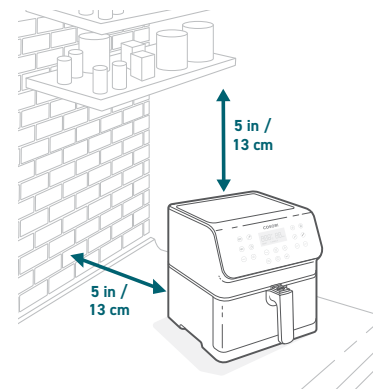

Figure 2.1

Basket Tips

- **Only** separate the baskets to clean or after cooking.
- The button guard protects the release button from being pressed accidentally. Slide the button guard forward to press the basket release button. [Figure 2.2]
- **Never** press the release button while carrying the baskets.
- **Only** press the basket release button with the baskets resting on a counter, or any level, heat-resistant surface.
- The handle is attached to the inner basket, not the outer basket. [Figure 2.3] When you press the release button, the outer basket will **drop**.

Note:

- **Do not** unscrew the basket handle from the baskets.
- To order accessories, please contact **Customer Support** (see page 25).

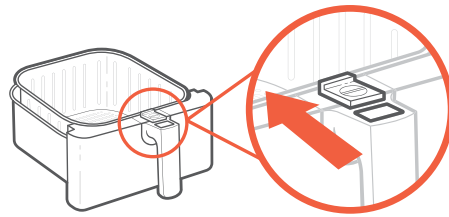

Figure 2.2



Figure 2.3

Rubber Stopper

- The inner basket contains a rubber stopper made of safe, FDA-approved material. This stopper prevents the inner basket from directly touching the outer basket and, in rare cases, damaging the non-stick coating on the baskets.
- The stopper can safely be removed based on user preference. For easy removal, start from the bottom of the inner basket and pull out one side of the stopper at a time. [Figure 2.4]
- If you want to place the rubber stopper back in the inner basket, first soak it in water. [Figure 2.5] Then push the stopper back in through the bottom of the basket. Push in one side of the stopper at a time.

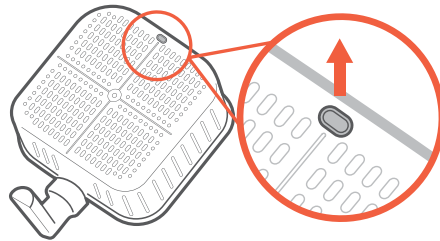

Figure 2.4

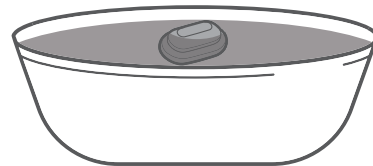

Figure 2.5

VeSync App Setup

Note: Due to ongoing updates and improvements, the VeSync app may be slightly different than shown in the manual. In case of any differences, follow the in-app instructions.

1. To download the VeSync app, scan the QR code or search "VeSync" in the Apple App Store® or Google Play Store.

Note: For Android™ users, choose "Allow" to use VeSync.

2. Open the VeSync app. If you already have an account, tap **Log In**. To create a new account, tap **Sign Up**.

Note: You must create your own VeSync account to use third-party services and products. These will not work with a guest account. With a VeSync account, you can also allow your family and friends to control your smart air fryer.



3. Tap **+** and select your smart air fryer.
4. Follow the in-app instructions to set up your smart air fryer.

Note:

- You can change the name and icon at any time by going to the smart air fryer screen and tapping .
- You can use the VeSync app to connect your smart air fryer to Amazon Alexa or Google Assistant™.

USING YOUR SMART AIR FRYER

Note: You can use the VeSync app to monitor cooking, follow in-app recipes, and access additional features. For a list of smart features, see **VeSync App Features** (page 19).

Preheating

We recommend preheating before placing food into the air fryer, unless your air fryer is already hot. Food will not cook thoroughly without preheating.

1. Plug in. Press  to turn on the display.
2. Press **Preheat**. The display will show "400°F" and "5 MIN".
3. Optionally, press the **+** or **-** buttons to change the temperature. The time will adjust automatically.

Temperature	Time
400°F / 204°C	5 minutes
390°F / 199°C	5 minutes
380°F / 193°C	5 minutes
370°F / 188°C	4 minutes
360°F / 182°C	4 minutes
350°F / 177°C	4 minutes
340°F / 171°C	4 minutes
330°F / 166°C and below	3 minutes

4. Press  to begin preheating.
5. When preheating is done, the air fryer will beep 3 times. The display will show the set preheat temperature. [Figure 3.1]

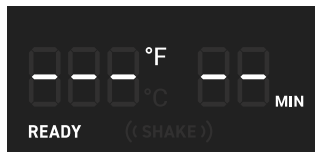

Figure 3.1

Note: If no buttons are pressed for 3 minutes, the air fryer will clear all settings and go into standby.

Air Frying

Note:

- **Do not** place anything on top of your air fryer. This will disrupt airflow and cause poor air frying results. [Figure 3.2]
- An air fryer is not a deep fryer. **Do not** fill the baskets with oil, frying fat, or any liquid.
- When taking the baskets out of the air fryer, be careful of hot steam, and **do not** press the basket release button.

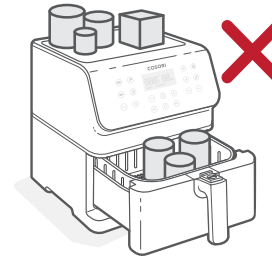

Figure 3.2

Preset Settings

Using a preset is the easiest way to air fry. Presets are programmed with an ideal time and temperature for cooking certain foods.

- You can customize a preset's time (1–60 minutes), temperature (170°–400°F / 77°–204°C), and Shake Reminder, unless noted.













Note: You can use multiple presets in one cooking session using the VeSync app.

- To change a preset's default settings:
 1. Choose a preset and adjust the time and/or temperature. Optionally, add or remove the Shake Reminder by pressing **SHAKE**.
 2. Press and hold the preset icon until the air fryer beeps 1 time.

Note: You can customize the time for the Shake Reminder using the VeSync app.

- To reset a preset:
 - Without making changes, press and hold both the preset icon and **Temp/Time** for 3 seconds until the air fryer beeps 1 time.
- To reset all presets:
 - Press and hold both **+** and **-** for 3 seconds until the air fryer beeps 1 time.

Results may vary. Check out our Quick Reference Guide and Recipe Book for a guide to customizing presets for perfect results.

Preset	Symbol	Default Temperature	Default Time	Shake Reminder?*
Steak		400°F / 204°C	6 minutes	-
Chicken		380°F / 193°C	23 minutes	-
Seafood		350°F / 177°C	8 minutes	-
Shrimp		370°F / 188°C	6 minutes	((SHAKE))
Bacon		320°F / 160°C	8 minutes	-
Frozen Foods		380°F / 193°C	8 minutes	((SHAKE))
French Fries**		380°F / 193°C	25 minutes	((SHAKE))
Vegetables		320°F / 160°C	8 minutes	((SHAKE))
Toast		320°F / 160°C	8 minutes	-
Bake		300°F / 149°C	35 minutes	-
Preheat		400°F / 204°C	5 minutes (auto adjust)	-
Keep Warm		170°F / 77°C	5 minutes	-

* See **Shaking Food** (page 16).

** See **Cooking Guide** (page 17) for tips on air frying french fries.

Air Frying

1. **Preheat your air fryer** (see page 12).
2. When your air fryer displays **"READY"**, add food to the baskets.
3. Select a preset (see page 13).

Note:

- You can also set a custom time and temperature without choosing a preset.
- You can use multiple presets in one cooking session using the VeSync app.

4. Optionally, customize the preset's temperature and time, and add a Shake Reminder. You can do this anytime during cooking.
 - a. Press **Temp/Time** to switch between controlling temperature or time. The temperature or time will blink on the display.
 - b. Press the **+** or **-** buttons to change the temperature (170°–400°F / 77°–204°C) or time (1–60 minutes).

Note:

- To rapidly increase or decrease time or temperature, press and hold the **+** or **-** buttons.
- If you do not press **Temp/Time**, pressing **+** or **-** will automatically change the temperature.

Air Frying (cont.)

- c. Press **SHAKE** to add or remove a Shake Reminder during cooking.
5. Press **▶||** to begin air frying.
 6. When Shake Reminder is turned on, it will appear halfway through the cooking time (unless customized using the VeSync app). The air fryer will beep 5 times, and **((SHAKE))** will blink on the display.
 - a. Take the baskets out of the air fryer, being careful of hot steam. The air fryer will pause cooking automatically, and the display will turn off until the baskets are replaced.
 - b. Shake or flip the food. Be careful not to press the basket release button.
 - c. Put the baskets back into the air fryer.

Note: See **Shaking Food** (page 16).

7. The air fryer will beep 3 times when finished. The display will show:

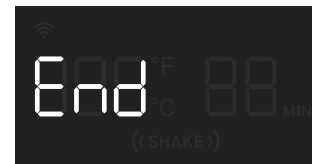

8. Optionally, press **Keep Warm**. Press the **+** or **-** buttons to change the time (1–60 minutes).
9. Take the baskets out of the air fryer, being careful of hot steam.

10. Remove the inner basket from the outer basket to serve food. When separating baskets:
 - a. Make sure the baskets are resting on a flat surface.
 - b. Watch for hot oil or fat collected in the outer basket. To avoid splashing, drain oil before replacing inner basket. [Figure 3.3]
11. Allow to cool before cleaning.

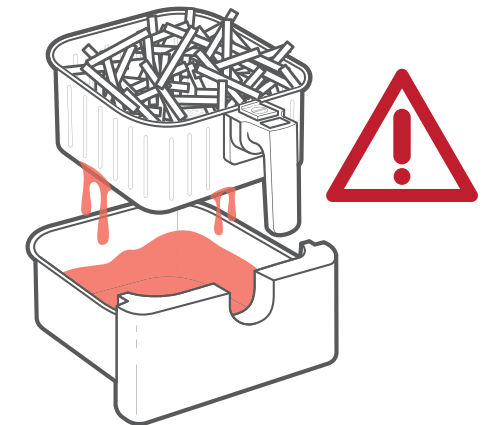

Figure 3.3

Shaking Food

How to Shake

- During cooking, take the baskets out of the air fryer and shake, mix, or flip the food.
 - A. To shake food:
 1. Hold the baskets just above a heat-resistant surface for safety purposes. **Do not** press the basket release button.
 2. Shake the baskets.
 - B. If the baskets are too heavy to shake:
 1. Place the baskets on a heat-resistant holder or surface.
 2. Separate the baskets. Make sure no liquids are dripping from the inner basket.
 3. Carefully shake the inner basket.

Note: **Do not** use this method if there is a risk of hot liquids splashing.

- C. If the baskets are too heavy to shake and there are hot liquids present:
 1. Place the baskets on a heat-resistant holder or surface.
 2. Use tongs to mix or flip the food.
- When you take the baskets out, the air fryer will pause cooking automatically. As a safety feature, the display will turn off until the baskets are replaced.
 - When you replace the baskets, cooking will automatically resume.
 - Avoid shaking longer than 30 seconds, as the air fryer may start to cool down.

What to Shake

- Small foods that are stacked, such as fries or nuggets, will usually need shaking.
- Without shaking, food may not be crispy or evenly cooked.
- You can flip other food, such as steak, to ensure even browning.

When to Shake

- Shake or flip food once halfway through cooking, or more if desired.
- The Shake Reminder is designed to remind you to check on your food. Tap **SHAKE** to turn on the Shake Reminder. Certain presets use the Shake Reminder automatically (see **Preset Settings**, page 13).
- The Shake Reminder will appear halfway through cooking time. This can be changed using the VeSync app.

Shake Reminder

- The Shake Reminder will alert you with 5 beeps, and **"((SHAKE))"** will blink on the display.
- If you do not remove the baskets, the Shake Reminder will beep again after 1 minute and the display will show a solid **"((SHAKE))"**.
- The Shake Reminder will go away once you take out the baskets.

Cooking Guide

Overfilling

- If the baskets are overfilled, food will cook unevenly.
- Baskets should not be filled over the "MAX" line in the inner basket. [Figure 3.4] **Do not** pack in food.



Figure 3.4

Using Oil

- Adding a small amount of oil to your food will make it crispier. Use no more than 2 US tbsp / 30 mL of oil.
- Oil sprays are excellent for applying small amounts of oil evenly to all food items.

Note: For more from the Cosori Kitchen, check out our *Recipe Book* and *Tips from the Chef*.

Food Tips

- You can air fry any frozen foods or goods that can be baked in an oven.
- To make cakes, hand pies, or any food with filling or batter, place food in a heat-safe container before placing it in the baskets.
- Air frying high-fat foods will cause fat to drip to the bottom of the baskets. To avoid excess smoke while cooking, pour out fat drippings after cooking.
- Liquid-marinated foods create splatter and excess smoke. Pat these foods dry before air frying.

French Fries

- Add ½–1 US tbsp / 8–15 mL oil for crispiness.
- When making fries from raw potatoes, soak uncooked fries in water for 15 minutes to remove starch. Pat dry with a towel before adding oil.
- Cut uncooked fries smaller for crispier results. Try cutting fries into ¼- by 3-inch / 0.6- by 7.6- cm strips.

More Functions

Switching Temperature Units

1. Press and hold **Temp/Time** for 3 seconds.
2. The air fryer will beep once, and the temperature unit will change from Fahrenheit to Celsius.
3. Repeat to switch back to Fahrenheit.

Pausing

- Press **▶||** to pause cooking. The air fryer will stop heating, and **▶||** will blink until you press **▶||** again to resume cooking.
- After 30 minutes of inactivity, the air fryer will turn off.
- This function allows you to pause the cooking program without removing the baskets from the air fryer.

Automatically Resume Cooking

- If you pull out the baskets, the air fryer will pause automatically. The display will turn off temporarily as a safety feature.
- When you return the baskets, the air fryer will automatically resume based on your previous settings.

Automatic Shutoff

- If the air fryer has no active cooking programs, it will clear all settings and turn off after 3 minutes of inactivity.

Overheat Protection

- If the air fryer overheats, it will automatically shut down as a safety feature.
- Let the air fryer cool down completely before using it again.

VeSync App Features

The VeSync app allows you to access additional smart air fryer functions, including those listed below.

Remote Control

- All smart air fryer functions can be controlled remotely, except for starting cooking (to comply with UL safety regulations).
- Cooking progress can be monitored from a distance.

Preset Customization

- The time that the Shake Reminder appears during cooking can be customized.
- New custom presets can be created.

Custom Cooking Programs

- Multiple presets can be combined to make customized cooking programs for multi-phase cooking.

Note: *The VeSync app is continually updated and app features will expand.*

In-App Recipes

- Pre-programmed recipes made by Cosori's in-house chefs are available in the app. These recipes automatically set the recommended time and temperature.
- Create and save custom recipes.

Third-Party Voice Control

- Compatible with Amazon Alexa and Google Assistant™ for voice commands.

ACCESSORIES

You can purchase accessories for your smart air fryer from Cosori's online store. Go to **cosori.com** for more information.

If you have any questions, please contact **Customer Support** (see page 25).

CARE & MAINTENANCE

Note:

- **Always** clean the air fryer baskets and interior after every use.
- Lining the outer basket with foil may make cleanup easier.

1. Turn off and unplug the air fryer. Allow it to cool completely before cleaning. Pull out the baskets for faster cooling.
2. Wipe the outside of the air fryer with a moist cloth, if necessary.
3. The baskets are dishwasher safe. You can also wash the baskets with hot, soapy water and a non-abrasive sponge. Soak if necessary.

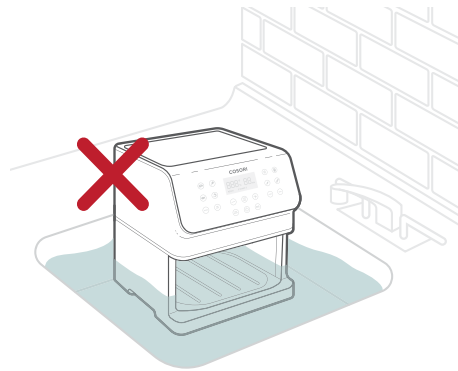

Figure 4.1

Note: The baskets have a nonstick coating. Avoid using metal utensils and abrasive cleaning materials.

4. For stubborn grease:
 - a. In a small bowl, mix 2 US tbsp / 30 mL of baking soda and 1 US tbsp / 15 mL of water to form a spreadable paste.
 - b. Use a sponge to spread the paste on the baskets and scrub. Let the baskets sit for 15 minutes before rinsing.
 - c. Wash baskets with soap and water before using.
5. Clean the inside of the air fryer with a slightly moist, non-abrasive sponge or cloth. **Do not** immerse in water. [Figure 4.1] If needed, clean the heating coil to remove food debris.
6. Dry before using.

Note: Make sure the heating coil is completely dry before turning on the air fryer.

TROUBLESHOOTING

Problem	Possible Solution
The air fryer will not turn on.	Make sure the air fryer is plugged in.
	Push the baskets securely into the air fryer.
Food is not completely cooked.	Place smaller batches of food into the inner basket. If the basket is overstuffed, then food will be undercooked.
	Increase cooking temperature or time.
Food is cooked unevenly.	Foods that are stacked on top of each other or close to each other need to be shaken or flipped during cooking (see Shaking Food , page 16).
Food is not crispy after air frying.	Spraying or brushing on a small amount of oil can increase crispiness (see Cooking Guide , page 17).
French fries are not cooked correctly.	See French Fries , page 17.
Baskets will not slide into the air fryer securely.	Make sure the inner basket is not overfilled.
	Make sure the inner basket is securely inside the outer basket.
White smoke or steam is coming out of the air fryer.	The air fryer may produce some white smoke or steam when you use it for the first time or during cooking. This is normal.
	Make sure the baskets and the inside of the air fryer are cleaned properly and not greasy.
	Cooking greasy foods will cause oil to leak into the outer basket. This oil will produce white smoke, and the baskets may be hotter than usual. This is normal, and should not affect cooking. Handle baskets with care.

TROUBLESHOOTING

Problem	Possible Solution
Dark smoke is coming out of the air fryer.	Immediately unplug your air fryer. Dark smoke means that food is burning or there is a circuit problem. Wait for smoke to clear before pulling the baskets out. If the cause was not burnt food, contact Customer Support (see page 25).
The air fryer has a plastic smell.	Any air fryer may have a plastic smell from the manufacturing process. This is normal. Follow the instructions for a Test Run (page 9) to get rid of the plastic smell. If a plastic smell is still present, please contact Customer Support (see page 25).
Display shows Error Code "E1".	There is an open circuit in the temperature monitor. Contact Customer Support (see page 25).
Display shows Error Code "E2".	There is a short circuit in the temperature monitor. Contact Customer Support (see page 25).
Display shows Error Code "E3".	The air fryer's overheat protection has activated. Turn off and unplug the air fryer and allow it to cool completely. If the display continues to show "E3", contact Customer Support (see page 25).
Display shows Error Code "E4".	The air fryer has been plugged into a 220–240V outlet. Unplug the air fryer. Only use the air fryer with 120V, 60Hz outlets.

If your problem is not listed, please contact **Customer Support** (see page 25).

FCC STATEMENT

This device complies with Part 15 of the FCC Rules. Operation is subject to the following two conditions:

- (1) This device may not cause harmful interference, and
- (2) This device must accept any interference received, including interference that may cause undesired operation.

Any changes or modifications not expressly approved by the party responsible for compliance could void the user's authority to operate this equipment.

This equipment has been tested and found to comply with the limits for a Class B digital device, pursuant to Part 15 of the FCC Rules. These limits are designed to provide reasonable protection against harmful interference in a residential installation. This equipment generates, uses and can radiate radio frequency energy and, if not installed and used in accordance with the instructions, may cause harmful interference to radio communications. However, there is no guarantee that interference will not occur in a particular installation. If this equipment does cause harmful interference to radio or television reception, which can be determined by turning the equipment off and on, the user is encouraged to try to correct the interference by one of the following measures:

- Reorient or relocate the receiving antenna.
- Connect the equipment into an outlet on a circuit different from that to which the receiver is connected.
- Increase the separation between the equipment and receiver.
- Consult the dealer or an experienced radio/TV technician for help.

FCC Radiation Exposure Statement

This equipment complies with FCC radiation exposure limits set forth for an uncontrolled environment. End users must follow the specific operating instructions for satisfying RF exposure compliance. To maintain compliance with FCC RF exposure compliance requirements, please follow operation instructions as documented in this manual. This transmitter must not be co-located or operating in conjunction with any other antenna or transmitter. This equipment should be installed and operated with a minimum distance of 20 cm between the radiator and your body. The availability of some specific channels and/or operational frequency bands are country dependent and are firmware programmed at the factory to match the intended destination. The firmware setting is not accessible by the end user.

LIMITED ONE-YEAR WARRANTY

Product	Smart 5.8-Quart Air Fryer
Model	CS358-AF Series
<i>For your own reference, we strongly recommend that you record your order ID and date of purchase.</i>	
Order ID	
Date of Purchase	

TERMS & POLICY

Arovast Corporation ("Arovast") warrants this product to the original purchaser to be free from defects in material and workmanship, under normal use and conditions, for a period of one year from the date of original purchase.

Arovast agrees, at our option during the warranty period, to repair any defect in material or workmanship or furnish an equal product in exchange without charge, subject to verification of the defect or malfunction and proof of the date of purchase.

There is no other express warranty. This warranty does not apply:

- If the product has been modified from its original condition;
- If the product has not been used in accordance with directions and instructions in the user manual;
- To damages or defects caused by accident, abuse, misuse or improper or inadequate maintenance;
- To damages or defects caused by service or repair of the product performed by an unauthorized service provider or by anyone other than Arovast;
- To damages or defects occurring during commercial use, rental use, or any use for which the product is not intended;
- To damages or defects exceeding the cost of the product.

Arovast will not be liable for indirect, incidental, or consequential damages in connection with the use of the product covered by this warranty.

This warranty extends only to the original consumer purchaser of the product and is not transferable to any subsequent owner of the product regardless of whether the product is transferred during the specified term of the warranty.

This warranty does not extend to products purchased from unauthorized sellers. Arovast's warranty extends only to products purchased from authorized sellers that are subject to Arovast's quality controls and have agreed to follow its quality controls.

All implied warranties are limited to the period of this limited warranty.

This warranty gives you specific legal rights and you may also have other rights which vary from state to state. Some states do not allow the exclusion or limitation of incidental or consequential damages, so the above limitation or exclusion may not apply to you.

If you discover that your product is defective within the specified warranty period, please contact Customer Support via support@cosori.com. DO NOT dispose of your product before contacting us. Once our Customer Support Team has approved your request, please return the product with a copy of the invoice and order ID.

Extend Your Warranty by 1 Year

Register your product within 14 days of purchase at www.cosori.com/warranty to extend your 1-year warranty by an additional year.

This warranty is made by:

Arovast Corporation
1202 N. Miller St. Suite A
Anaheim, CA 93806

CUSTOMER SUPPORT

If you have any questions or concerns about your new product, please contact our helpful Customer Support Team.

Arovast Corporation

1202 N. Miller St., Suite A
Anaheim, CA 92806

Email: support@cosori.com

Toll-Free: (888) 402-1684

Support Hours

Mon–Fri, 9:00 am–5:00 pm PST/PDT

**Please have your invoice and order ID ready before contacting Customer Support.*

TRADEMARK INFORMATION

Amazon, Alexa, and all related logos are trademarks of Amazon.com, Inc. or its affiliates.

Google and Google Play are trademarks of Google LLC.

Apple App Store is a trademark of Apple Inc.

Wi-Fi® is a registered trademark of Wi-Fi Alliance®.

COSORI

Questions or Concerns?

Mon–Fri, 9:00 am–5:00 pm PST/PDT
support@cosori.com | (888) 402-1684